

OUTDOOR SOLUTIONS



STARPOOL

wellness concept

Welcome to
a new dimension
of Wellness



Summary

Well-being from nature	7
-------------------------------	---

I.CON COLLECTION

The new idea of wellness	11
---------------------------------	----

I.con Sauna and I.con Relax: make way to Wellness	12
---	----

The beauty of versatility	13
---------------------------	----

I.con Sauna	15
--------------------	----

Functional design	16
-------------------	----

Outfitting	18
------------	----

Technical data	22
----------------	----

Layout	24
--------	----

I.con Relax	27
--------------------	----

Valuable relaxation	28
---------------------	----

Functional design	30
-------------------	----

Outfitting	32
------------	----

Technical data	36
----------------	----

Layout	37
--------	----

NATURE SAUNA

Feeling good in contact with nature	41
Nature Sauna pro	43
Functional design	44
Outfitting	46
Technical data	48
Layout	50
Nature Sauna personal	53
Functional design	54
Outfitting	56
Technical data	60
Layout	61

SMART TECHNOLOGY

Smart Technology	64
-------------------------	----

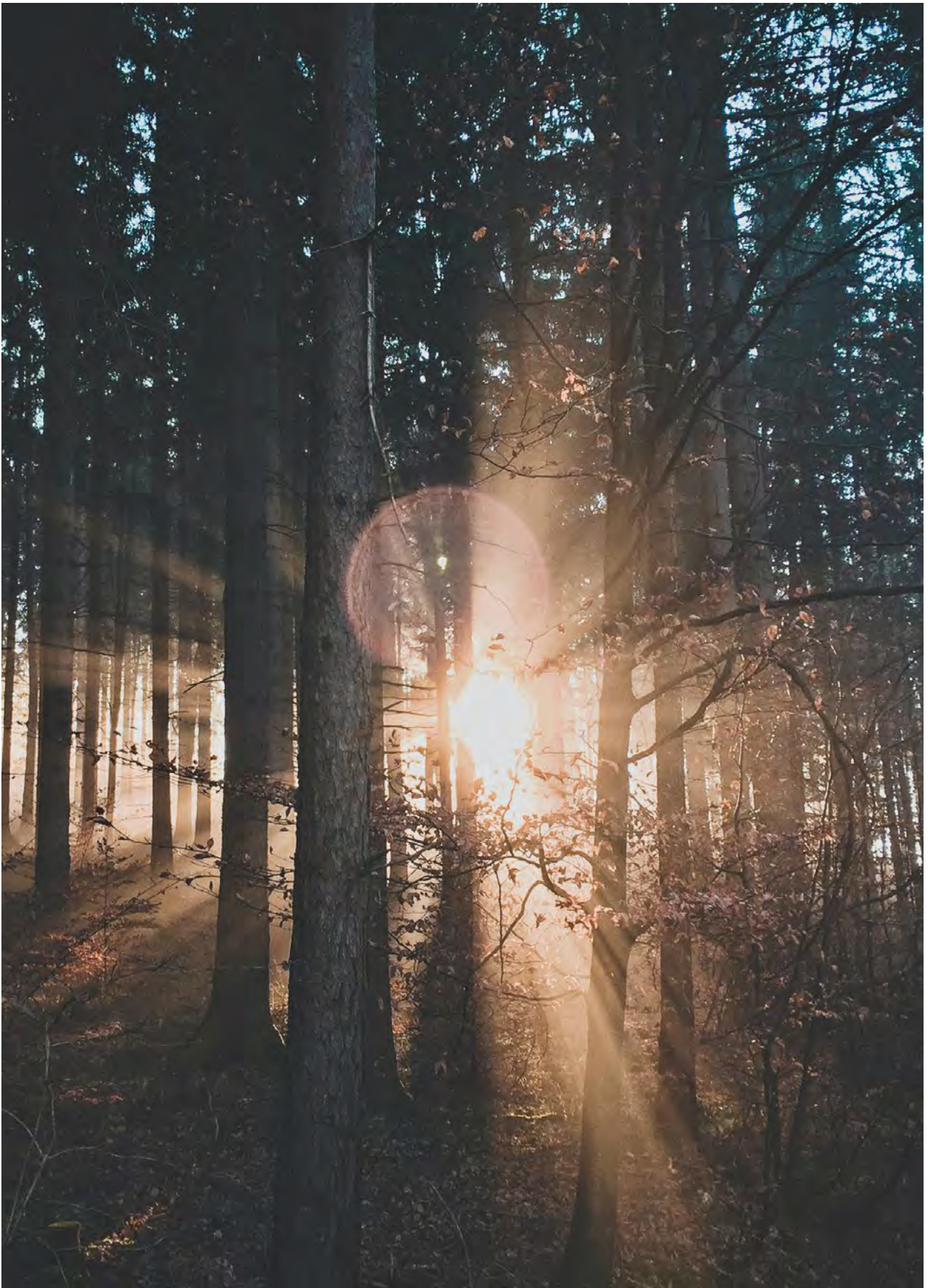

Well-being from nature

Our daily life happens mainly indoors: between school, office, home, shops, we spend the most part of our days in enclosed environments, with virtually no benefit **for psycho-physical well-being**.

Regaining the connection with nature and enjoying experiences in the open air is a desire that is currently bringing together more and more people, who seek a chance for regeneration and to find a new well-being far from daily routine.

Our outdoor Wellness solutions create connections and new types of balance with the outside world, through **unique regeneration and relaxation spaces**, designed to fulfil every kind of need in terms of **health** and **self-care**. Products that create a synergy with the environment also in the consistency of design and choices that are **sustainable and environment-friendly**.

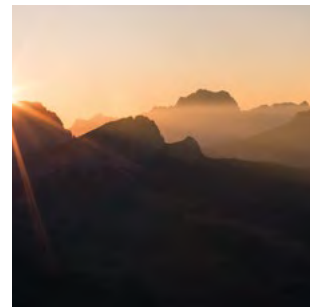
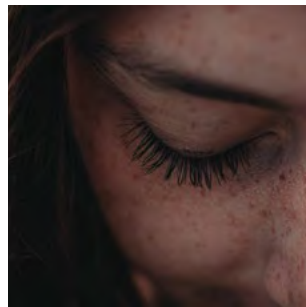
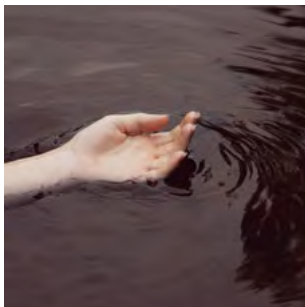

I.con Collection

DESIGN: MFOR

I.con Collection is the **great innovation for the outdoors** that puts sustainable architecture in the service of psycho-physical well-being.

A collection **developed from the recovery of cargo containers**, and characterised by exclusive design.







The new idea of wellness

They come from far-off lands, they have travelled the world, fighting the winds and the sea. They are the great travellers that leave the cargo sector for a new route.

The containers preserve their distinctive nomadic spirit but, instead of shipping goods all over the world, they become **wellness spaces** where to relax your body and free your mind.

The door opens, you get on board and sail towards cosy places, to enjoy the benefits of the sauna and treat yourself to moments of authentic relaxation.



They are **versatile installations characterised by simple lines** and by a strong identity conveyed by their unique design.

Fully equipped regeneration spaces that breathe new life into the environment, and meet the individual's increasingly rooted need of reconnecting and integrating with it.

I.con Sauna and I.con Relax: make way to Wellness

I.con Collection features **I.con Sauna** and **I.con Relax**, enchanting places of refuge, symbols of the versatility of well-being. These containers allow you to **create stable or temporary wellness areas**, that can be moved easily, according to specific needs.



Easy to install, I.con Sauna and I.con Relax **enhance the place where they are set**, in a harmonious connection with the surrounding landscape.

They can be placed in the outdoor areas of hotels, residences and camping sites. They are the ideal solution for facilities working on a seasonal basis, or for special initiatives and events, but also in private buildings, in a garden or in the city centre.

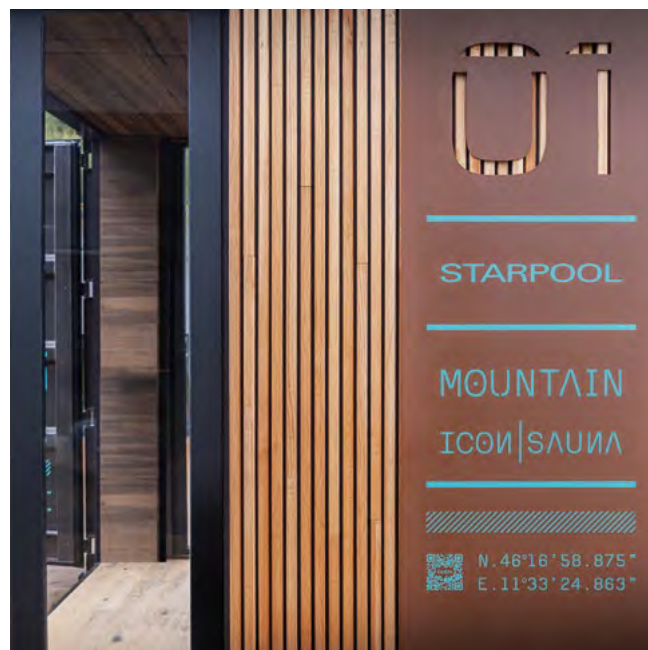

The beauty of versatility



URBAN

The skyscrapers of the modern iconic metropolises have laid the foundations for the development of the Urban mood, characterised by metal parts and shades of grey that recall the façades of the distinctive big-city buildings.

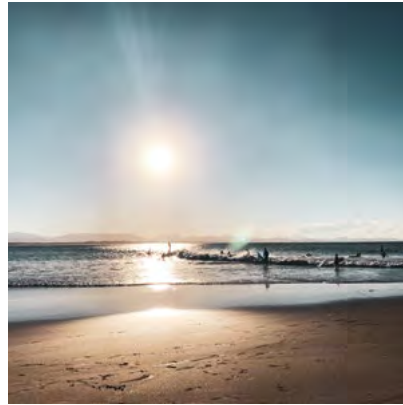

BEACH

The intentionally faded shades evoke the soft colours of the sand and reproduce the typical air of the iconographic seaside resorts, transformed over time by the sea and wind erosion.



MOUNTAIN

The magnificence of mountain landscapes is felt through the scents and the colours of the woods. The Mountain outfitting evokes the atmosphere of the woods, which conveys the typical sense of nature offered by the mountains.



[Discover more on I.con Sauna](#)

I.CON SAUNA

I.con Sauna

INTENSE HEAT

I.con Sauna combines **the tradition of the Finnish sauna** with the design innovation of **cutting-edge architecture**. It is a fully equipped and regenerated container with a unique and exclusive design.

Also available in the **Soft Sauna version**, characterised by a mild heat, for a gentle and embracing wellness experience.

A cosy place that allows you to create **wellness areas to meet any need in terms of space**, from the smallest to the largest.

The containers are in fact available in two dimensions:
10 or 20 feet.

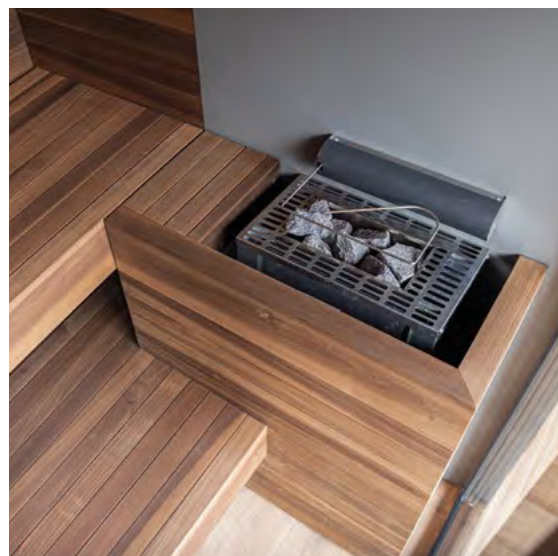
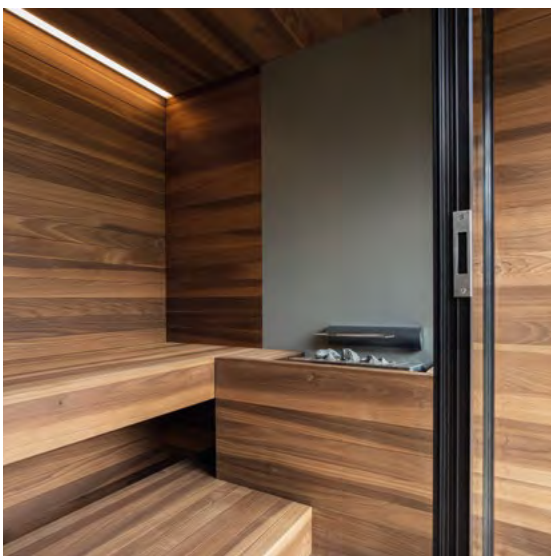

Functional design

The design by Starpool is the right balance between beauty and function. The resulting environment then fulfils not just the appearance, but also meets specific requirements both in terms of space and sustainability.

1. DOOR

Comfort, convenience and accessibility thanks to the door now increased in width to 87 cm.

2. TOUCH DISPLAY

A practical touch-screen display with an intuitive interface that allows to browse quickly and easily through the functions of I.con Sauna. The touch-screen display is installed on the carriage technical compartment in the 10-feet container and on the entrance wall in the 20-feet container.

3. LIGHTING

A cascade of indirect white light illuminates the environment, enhancing the natural effect of the materials. An even, diffused blaze, whose intensity can be regulated thanks to the dimmable led-light bar installed on the back wall.

4. NATURAL AIR EXTRACTION

The system of bottom-up natural air extraction ensures continuous recirculation and clean air.

5. SUSPENDED BENCH

The suspended bench favours cleaning operations.

6. SAFETY AND MONITORING

The stove is placed in a safe position, and it does not come into direct contact with the structure of the cabin thanks to the porcelain gres covering the wall behind it. The pressure-activated system on the stove cuts the power supply to it, thus ensuring greater safety. The alarm button inside the cabin stops all the functions and cuts the power supply.

7. TECHNICAL COMPARTMENT

In the 10-feet container, the technical compartment is installed in a sliding carriage, which allows to carry out all ordinary maintenance operations easily and independently. In the 20-feet container, the technical compartment is wall-installed.

8. FRAME

The access to the container consists of a double-glazed door (6/18/6), secured by a frame in black anodised aluminium complete with lock. In the 20-feet container, the same "frame-like" effect is also present on the side glass wall.

9. DIMENSIONS

The containers are available in two versions: 10 feet and 20 feet.

CONVENIENCE

I.con Sauna is a "turnkey" Finnish Sauna kind of model. The installation is quick and safe, and the product can be repositioned elsewhere any time.

BE GREEN

The system **GREEN PACK** is fitted as standard on I.con Sauna: self-closing door, open-door detector that can stop the heat production, "Energy Efficient" software to monitor the maintenance of the temperature. All of this favours the optimization of energy consumption, avoiding unnecessary waste.

I.CON SAUNA



Outfitting

URBAN



External cladding

- Container for I.con Sauna with Monza grey Magno (RAL 054) finish.
- I.con Collection sticker graphics
- Double-glazed (6/18/6) front glass wall with black anodised aluminium frame

Internal cladding

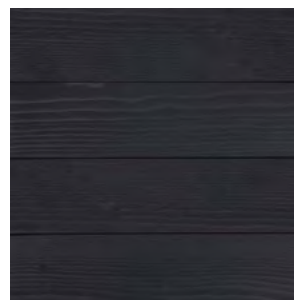

Savublack Fir
Walls, benches, ceiling and external infills in black-waxed fir

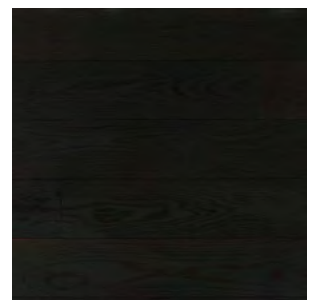

Black-oiled Oak
Floor in black-oiled oak

BEACH



External cladding

- Container for I.con Sauna with Signal White (RAL 9003) finish.
- External cladding in bleached pine
- Roof flashings
- I.con Collection sticker graphics
- External sheet in satin steel
- Double-glazed (6/18/6) front glass wall with black anodised aluminium frame

Internal cladding



White Waxed Fir
Walls, benches, ceiling and external infills in white-waxed fir



White-oiled Oak
Floor in white-oiled oak

I.CON SAUNA

MOUNTAIN



External cladding

- Container for I.con Sauna with dark brown (RAL 8019) finish.
- Cladding in vertical larch slats
- Roof flashings
- External sheet in CORTEN effect steel
- I.con Collection sticker graphics
- Double-glazed (6/18/6) front glass wall with black anodised aluminium frame

Internal cladding

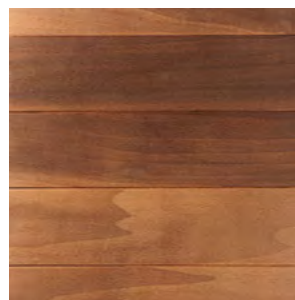

Tulipier Thermowood
Walls, benches, ceiling and external infills in Tulipier Thermowood

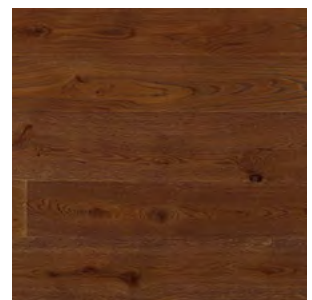

Thermowood Oak
Floor in thermowood natural oak



Technical data

Container dimensions (cm) 10 ft	open close	439 w x 414 d x 259 h 255 w x 305 d x 259 h
Container dimensions (cm) 20 ft	open close	439 w x 720 d x 259 h 255 w x 610 d x 259 h
Container weight (Kg)	10 ft 20 ft	2500 4300
Sauna dimensions (cm) 10 ft		195 w x 150 d x 230 h 195 w x 195 d x 230 h 195 w x 250 d x 230 h
Sauna dimensions (cm) 20 ft		490 w x 225 d x 230 h
Sauna weight (Kg) 10 ft		607 670 760
Sauna weight (Kg) 20 ft		1000
Voltage		400 Vac 3P+N+Pe
Max consumptium (kW)	10 ft 20 ft	8.0 15.5
Technical specification		Finnish Sauna Soft Sauna* *only available with manual water supply
Temperature	Finnish Sauna Soft Sauna	90 - 100 °C 50 - 60 °C
Humidity	Finnish Sauna Soft Sauna	10 - 20% 40 - 60%
Heating		Electric stove
Lighting		Ceiling-mounted 2700° K warm-white dimmable led-light bar
Music kit		Integrated music kit with Wellness Entertainment programs uploaded on mp3 player with Bluetooth technology
Necessary installations		Electrical connection Flat surface with loadbearing capacity from 300 to 400 Kg/sqm
Extras		Side windows 60x220cm with 6/18/6 double-glazed glass (available only in the 10-feet container)
Door handle		External handle in black steel Internal handle in the same wood as internal cladding Handle height: 98 cm / square section 30x30 cm

I.CON SAUNA

Functions

ON / OFF	Through Touch Display
Lighting	Through Touch Display
Mp3 with music play / stop / rew / ff / volume +/-	Through Touch Display
Alarm	Through button inside sauna

Layout

10 ft

plan

section

195 x 150

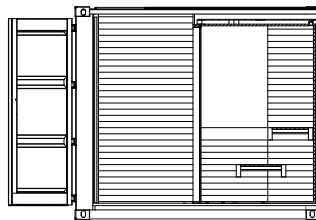
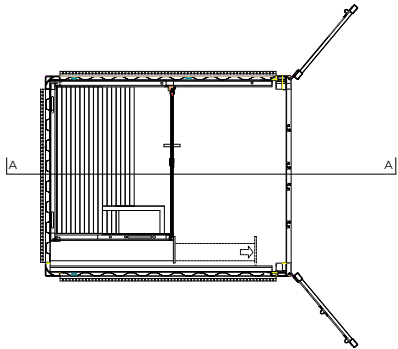

195 x 195

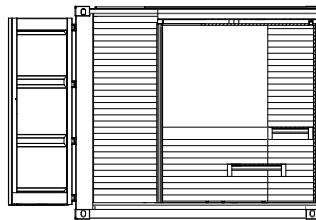
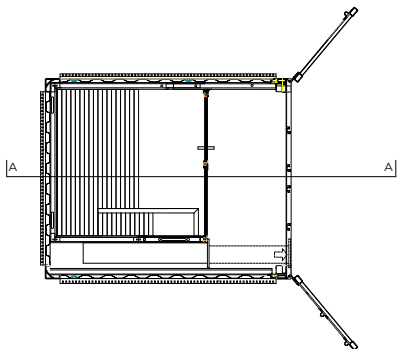

195 x 250

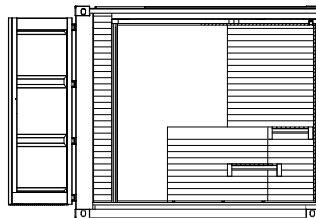
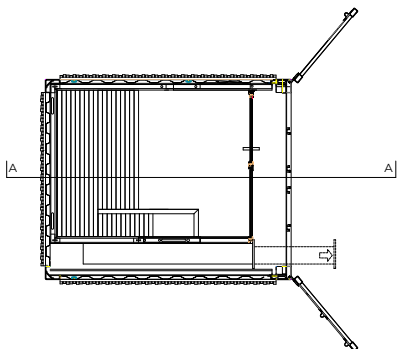

I.CON SAUNA

20 ft

plan

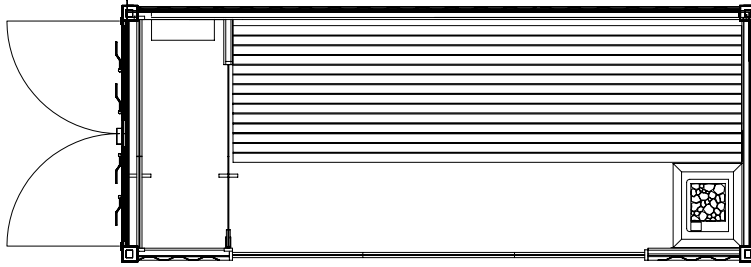

section





[Discover more I.con Relax](#)

I.con Relax

FOR YOUR REST AND PSYCHO-PHYSICAL RECOVERY

I.con Relax allows you to live an **immersive wellness experience** in the surrounding landscape.

It is the ideal place to rest, where the pleasant warmth of the stove allows you to let go to deep relaxation in name of sustainability.

Here, **relaxation triumphs** over the frenzy of our daily life. It is the perfect conclusion to every wellness program, after the exposure to heat and the cold reaction: the exact moment where you get in tune with the slow rhythm of nature to **regain the balance between body and mind** and obtain the maximum benefit.



Valuable relaxation

Our goal is to create **comfortable environments to favour deep relaxation** and full psycho-physical recovery. This is why we design **customisable relaxation areas** with products that can theme rest, while ensuring a complete wellness experience.

I.con Relax can be completed and enhanced with two of our solutions for deep relaxation.

Bridge Lounger

Bridge Lounger is our relaxation bed designed to be the perfect union between comfort and elegance. **Essential lines** and minimal design chiselled in oakwood give life to an ergonomic outline that embraces the body and transforms rest in a moment of authentic well-being.



Wellness Coach

Wellness Coach, the virtual guide for the well-being of body and mind, turns the moments dedicated to rest into actual experiences of psycho-physical regeneration. An **interactive system to feel good and fit**, through guided Mindfulness and Breathing programs developed with renowned partners in the fields of science and sport.

I.CON RELAX



[Discover more about Bridge Lounger](#)



[Discover more about Wellness Coach](#)

Functional design

The design by Starpool is the right balance between beauty and function. The resulting environment then fulfils not just the appearance, but also meets specific requirements both in terms of space and sustainability.

1. DOOR

Comfort, convenience and accessibility thanks to the door now increased in width to 87 cm.

2. EQUIPMENT CONTROL PANEL

A small technical compartment is installed on a retractable panel on the stove cover, and it allows to manage the settings of switching on and off for I.con Relax.

3. LIGHTING

A cascade of indirect light illuminates the inside, enhancing the natural effect of the materials. An even, diffused blaze, whose intensity can be regulated thanks to the white dimmable led-light bar installed on the back wall.

4. SAFETY AND MONITORING

The stove is placed in a safe position, and it does not come into direct contact with the structure of the cabin thanks to the porcelain gres covering the wall behind it.

5. FRAME

The access to the container consists of a double-glazed door (6/18/6), secured by a frame in black anodised aluminium complete with lock. In the 20-feet container, the same "frame-like" effect is also present on the side glass wall.

6. DIMENSIONS

The containers are available in two versions: 10 feet and 20 feet.

7. SOUND COMFORT

I.con Relax is realised with acoustic cladding installed on the walls and ceiling, for deep relaxation in name of sound comfort.



CONVENIENCE

I.con Relax is a versatile solution for an experience of deep relaxation in name of sustainability. The installation is quick and safe, and the product can be repositioned elsewhere any time.

BE GREEN

The system **GREEN PACK** is fitted as standard on I.con Relax: self-closing door, open-door detector that can stop the heat production, "Energy Efficient" software to monitor the maintenance of the temperature. All of this favours the optimization of energy consumption, avoiding unnecessary waste.

I.CON RELAX



Outfitting

URBAN



External cladding

- Container for I.con Relax with Monza grey Magno (RAL 054) finish.
- I.con Collection sticker graphics
- Double-glazed (6/18/6) front glass wall with black anodised aluminium frame

Internal cladding

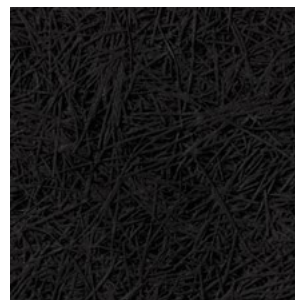

Heraklit Black

Walls and ceiling clad with acoustic panels in black heraklit mounted on a thermally-insulating structure

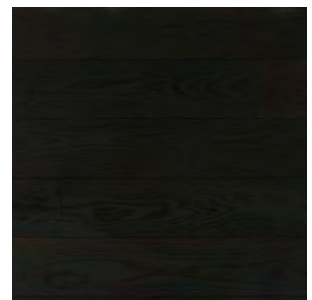

Black-oiled Oak

Floor in black-oiled oak

BEACH



External cladding

- Container for I.con Relax with Signal White (RAL 9003) finish.
- External cladding in bleached pine
- Roof flashings
- I.con Collection sticker graphics
- External sheet in satin steel
- Double-glazed (6/18/6) front glass wall with black anodised aluminium frame

Internal cladding



Heraklit White

Walls and ceiling clad with acoustic panels in white heraklit mounted on a thermally-insulating structure

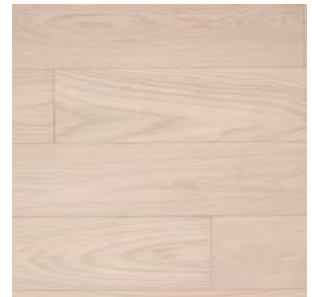

White-oiled Oak

Floor in white-oiled oak

MOUNTAIN



External cladding

- Container for I.con Relax with dark brown (RAL 8019) finish.
- Cladding in vertical larch slats
- Roof flashings
- External sheet in CORTEN effect steel
- I.con Collection sticker graphics
- Double-glazed (6/18/6) front glass wall with black anodised aluminium frame

Internal cladding

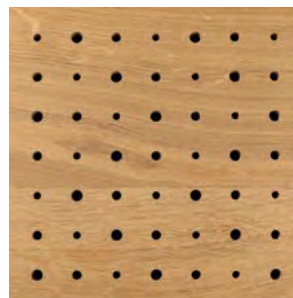

Natural Oak
Walls and ceiling clad with acoustic panels in natural oak mounted on a thermally-insulating structure

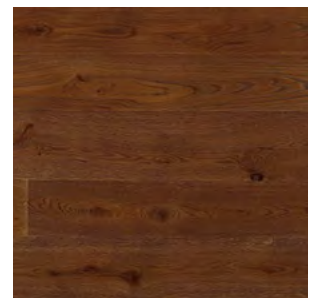

Thermowood Oak
Floor in thermowood natural oak



Technical data

Container dimensions (cm) 10 ft	open close	439 w x 414 d x 259 h 255 w x 305 d x 259 h
Container dimensions (cm) 20 ft	open close	439 w x 720 d x 259 h 255 w x 610 d x 259 h
Container weight (Kg)	10 ft 20 ft	2500 4300
Voltage		400 Vac 3P+N+Pe
Maximum consumption (kW)		4.5
Temperature		40 °C
Humidity		40 - 45%
Heating		4Kw electric stove
Lighting		Floor-mounted 2700° K warm-white dimmable led-light ray
Music kit		.
Frame / Door	10 ft 20 ft	Double-glazed (6/18/6) front glass wall with aluminium frame Three-door double-glazed (6/18/6) side glass wall, with central sliding door
Necessary installations		Electrical connection Flat surface with load-bearing capacity from 300 to 400 Kg/sqm
Extras	10 ft 20 ft	60x220 cm double-glazed (6/18/6) side windows Three-door double-glazed (6/18/6) side glass wall, with central sliding door Wellness Coach available for both dimensions with pre-uploaded Wellness Entertainment programs and bluetooth loudspeakers
Door handle		External handle in black steel Internal handle in the same wood as internal cladding Handle height: 98 cm / square section 30x30 cm

I.CON RELAX

Functions

ON / OFF

Through equipment control panel

Lighting

Through equipment control panel

Layout

10 ft

plan

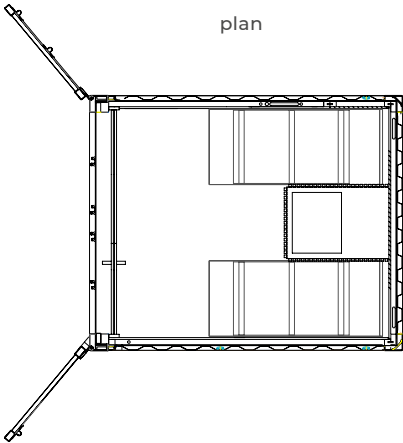

section

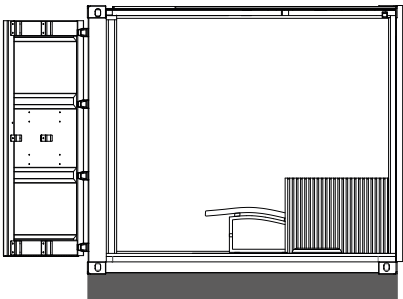

20 ft

plan

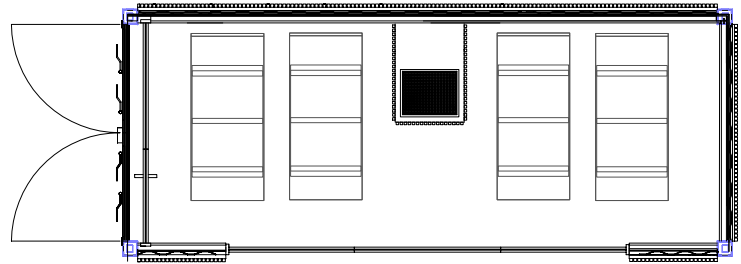

section

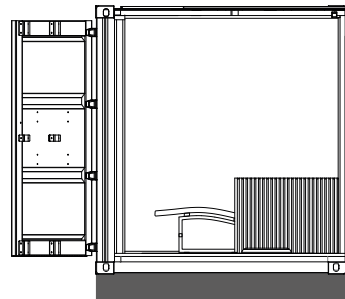



Nature Sauna

DESIGN: ALEDOLCI&CO.

What is natural is ever-changing.

Life, experience and time are mutually enhanced and transformed in a continuous exchange of energy.

That's what happens with **Nature Sauna**, a project that pulls together design and nature, **communicating with its surroundings** and creating a deep connection with the environment.





Feeling good in contact with nature

Nature Sauna transforms over time and space. Over the years, the materials change and shape a unique product, every day anew.

Nature Sauna offers the chance of an authentic sauna experience, and to **make the most of the regenerating power** of the cycles of nature, in every moment of the year and in any type of weather.

The need of balance and communication between man, landscape and architecture is completely fulfilled with **Nature Sauna**, in its two versions, **pro** and **personal**.

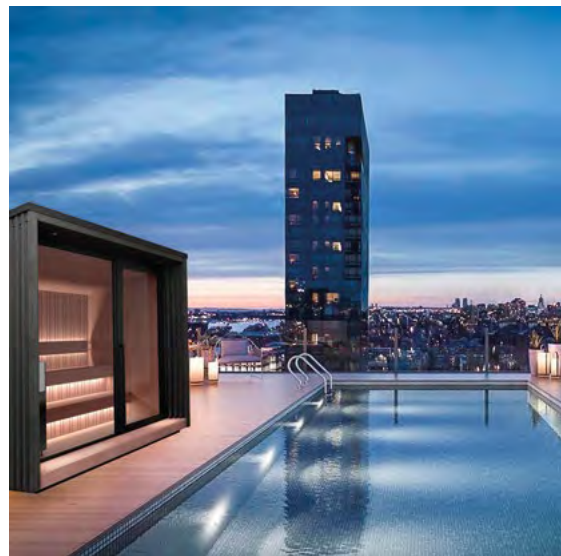



[Discover more on Nature Sauna pro](#)

Nature Sauna pro

INTENSE HEAT

It is the outdoor sauna designed for **social use**, combining the tradition of the **Finnish sauna** with the technological innovation of cutting-edge architecture.

Also available in the **Soft Sauna version**, characterised by a mild heat, for a gentle and embracing wellness experience.

A unique, discreet place where to enjoy moments of absolute relaxation while immersed in nature. A walkway is placed right outside the front glass wall, a comfortable external space for a proscenium effect with a panoramic view.

Nature Sauna Pro is designed to create a synergy with every context, and therefore offers new chances to the exclusive experiences dedicated to well-being.

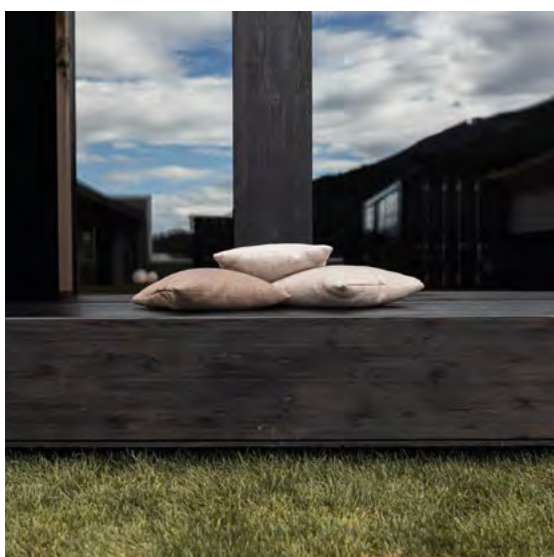

Functional design

The design by Starpool is the right balance between beauty and function. The resulting environment then fulfils not just the appearance, but also meets specific requirements both in terms of space and sustainability.

1. DOOR

Comfort, convenience and accessibility thanks to the door now increased in width to 87 cm.

2. LIGHTING

A cascade of indirect light naturally illuminates the inside, enhancing the natural effect of the materials. An even, diffused blaze, whose intensity can be regulated thanks to the white dimmable led-light bar installed under the bench and behind the stove.

3. NATURAL AIR EXTRACTION

The system of bottom-up natural air extraction ensures continuous recirculation and clean air.

4. BENCH

The bench is readily serviceable, thanks to an upward pivoting mechanism that favours cleaning operations.

5. SAFETY AND MONITORING

The stove, natural centre of the sauna, is placed in a safe position, and it does not come into direct contact with the structure of the cabin thanks to the gres porcelain covering the wall behind it. The pressure-activated system on the stove cuts the power supply to it, thus ensuring greater safety. The alarm button inside the cabin stops all the functions and cuts the power supply.

6. TECHNICAL COMPARTMENT

The control panel is accessed from the entry cubicle, through its specific lock.

7. ENTRY CUBICLE

Equipped with ceiling-mounted infra-red lamp and entry door with handle and lock.

8. WALKAWAY

A comfortable space outside the sauna front double-glazed glass wall, and shaded on both sides by the pattern drawn by the wood slats, to sit comfortably with a proscenium-effect view on the outside. Practical hangers for towels are available in the entry cubicle.

9. FRAME

The front features a wooden frame matching the colour of the internal/cladding, equipped with 8/9/10 double-glazed glass wall.

CONVENIENCE

Nature Sauna Pro is a "turnkey" Finnish Sauna kind of model. The installation is quick and safe, and the product can be disassembled and assembled again elsewhere.

BE GREEN

The system **GREEN PACK** is fitted as standard on Nature Sauna pro: self-closing door, open-door detector that can stop the heat production, "Energy Efficient" software to monitor the maintenance of the temperature. All of this favours the optimization of energy consumption, avoiding unnecessary waste.

NATURE SAUNA PRO



Outfitting



External cladding



Savublack Fir
External cladding in
black-waxed fir

Internal cladding

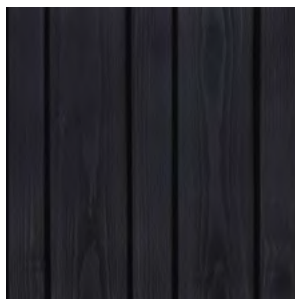

Savublack Fir
Walls, benches, ceiling in
black-waxed fir

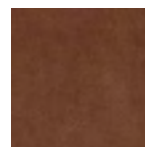

Terracotta Gres

Cladding behind the stove and
on the wall of the entry cubicle
in Terracotta gres porcelain



Carbon Gres

Cladding behind the stove and
on the wall of the entry cubicle in
Carbon porcelain gres

NATURE SAUNA PRO



External cladding

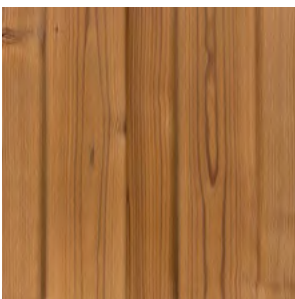

Thermowood Fir
External cladding in thermowood fir

Internal cladding

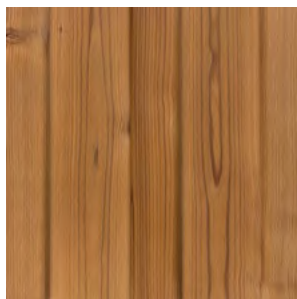

Thermowood Fir
Walls, benches, ceiling in thermowood fir

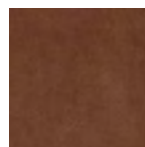

Terracotta Gres

Cladding behind the stove and on the wall of the entry cubicle in Terracotta gres porcelain

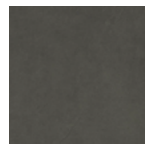

Carbon Gres

Cladding behind the stove and on the wall of the entry cubicle in Carbon porcelain gres

Technical data

External dimensions (cm)	Small Medium Large	369 w x 317 d x 272/320 h 473 w x 317 d x 272/320 h 577 w x 317 d x 272/320 h
Sauna dimensions (cm)		214 w x 216 d 318 w x 216 d 421 w x 216 d
Voltage		400 Vac 3P+N+Pe
Maximum consumption (kW)	Small Medium Large	9,5 12,5 15,5
Technical specification		Finnish Sauna Soft Sauna* *only available with manual water supply
Temperature	Finnish Sauna Soft Sauna	90 - 100 °C 50 - 60 °C
Humidity	Finnish Sauna Soft Sauna	10 - 20% 40 - 60%
Heating inside the sauna		Electric stove
Heating in the entry cubicle		Infra-red lamp
Lighting inside the cabin		2700°K white led-light bar placed under the benches and behind the backrest
Lighting in the entry cubicle		Amber led spotlight
Music kit		Integrated music kit with Wellness Entertainment programs uploaded on mp3 player with Bluetooth technology
Handle / door		External handle in black steel 316L Internal handle in the same wood as internal cladding Handle height: 98 cm / square section 30x30 cm
Entry cubicle handle		Internal/external handle in 316L steel, black-coated (with Savu Black cladding) or chrome-plated (on Thermowood fir cladding)
Structure		Self-bearing wooden structure, mountable on site (minimum thickness 21 cm, U=0,2W/sqmK)
Snow load		300 Kg/sqm

NATURE SAUNA PRO

Functions

ON / OFF	Through technical compartment
Lighting	Through technical compartment
Mp3 with music play / stop / rew / ff / volume +/-	Through technical compartment
Alarm	Through button inside sauna

Layout

Layout B

plan

side view

front view

Small

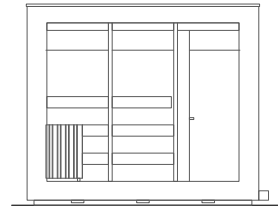
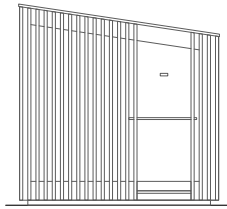

Medium

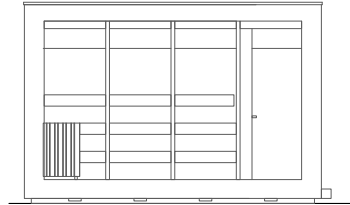
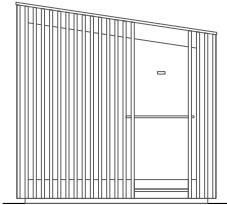
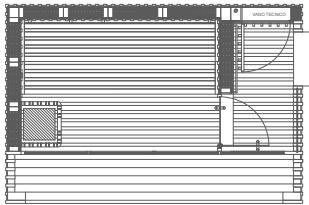

Large

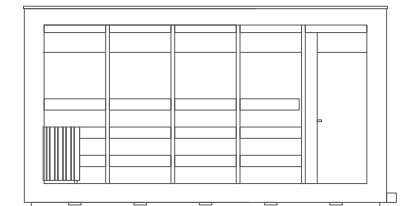
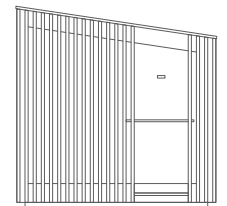
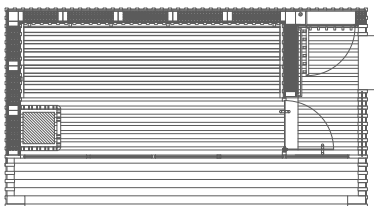

NATURE SAUNA PRO

Layout C

plan

front view

side view

Small

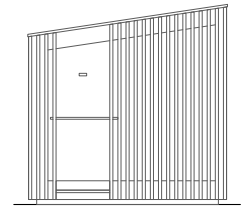
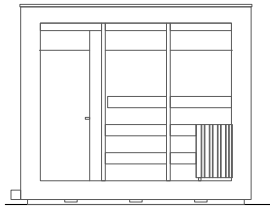
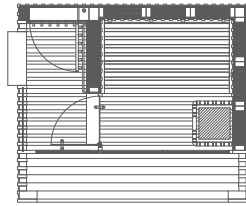

Medium

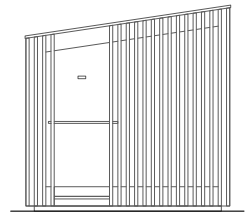
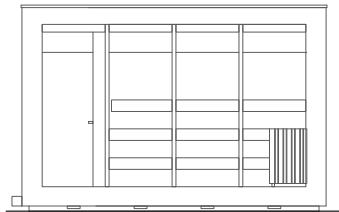
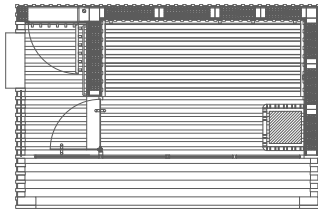

Large

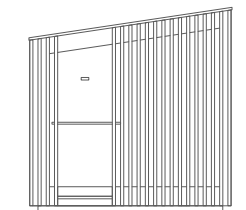
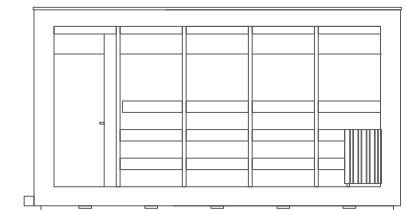



[Discover more on Nature Sauna personal](#)

NATURE SAUNA PERSONAL

Nature Sauna personal

INTENSE HEAT

It is the **Finnish sauna** that combines the individual's need to reconnect with nature with the need to take care of oneself in the privacy of one's own home.

All the **professionalism and technology of the outdoor products** of the pro line, in an ideal solution for home use.

Also perfect to **improve the offer of hotels and day spas** that have suites and private gardens to dedicate to private Wellness.

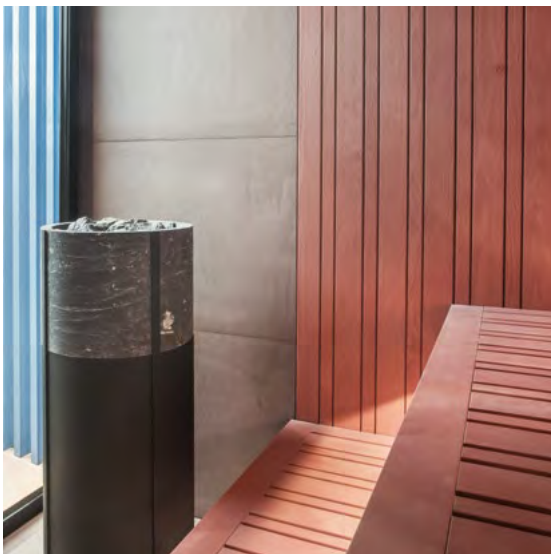

Functional design

The design by Starpool is the right balance between beauty and function. The resulting environment then fulfils not just the appearance, but also meets specific requirements both in terms of space and sustainability.

1. DOOR

Comfort, convenience and accessibility thanks to the door now increased in width to 87 cm.

2. REMOTE TOUCH DISPLAY

A practical touch-screen display with an intuitive interface that allows to browse quickly and easily through the functions of Nature Sauna personal.

3. MY W-PLACE

The App to manage your spa remotely and enhance your Wellness experience with Brain Training contents, like Mindfulness and guided breathing techniques, as well as protocols of use developed on the basis of individual requirements in terms of health and well-being.

4. LIGHTING

A cascade of indirect light naturally illuminates the inside, enhancing the natural effect of the materials. An even, diffused blaze, whose intensity can be regulated thanks to the white dimmable led bar installed under the bench and behind the backrest.

5. NATURAL AIR EXTRACTION

The system of bottom-up natural air extraction ensures continuous recirculation and clean air.

6. BENCH

The bench is readily serviceable, thanks to an upward pivoting mechanism that favours cleaning operations.

7. SAFETY AND MONITORING

The stove, natural centre of the sauna, is placed in a safe position, and it does not come into direct contact with the structure of the cabin thanks to the gres porcelain covering the wall behind it.

8. TECHNICAL COMPARTMENT

The technical compartment is concealed in the space under the bench, and allows to carry out all ordinary maintenance operations easily and independently.

The alarm button inside the cabin stops all the functions and cuts the power supply.

9. FRAME

The access to the sauna consists of a double-glazed door (6/18/6), secured by a frame in black anodised aluminium complete with lock.

10. WALKAWAY

A comfortable space outside the sauna front double-glazed glass wall, and shaded on both sides by the pattern drawn by the wood slats, with a proscenium-effect view and easy access.

CONVENIENCE

Nature Sauna personal is a "turnkey" Finnish Sauna kind of model. The installation is quick and safe, and the product can be repositioned elsewhere any time.

NATURE SAUNA PERSONAL

LOW CONSUMPTION

The energy consumption is low and suitable for home use.

SUSTAINABILITY

Nature Sauna personal is also available with a wood-burning stove and specific lighting system, with no need for preliminary electrical connection.

BE GREEN

The system GREEN PACK is fitted as standard on Nature Sauna personal: self-closing door, open-door detector that can stop the heat production, "Energy Efficient" software to monitor the maintenance of the temperature. All of this favours the optimization of energy consumption, avoiding unnecessary waste.



Outfitting



External cladding

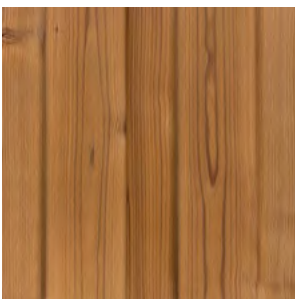

Thermowood Fir
External cladding in thermowood fir

Internal cladding

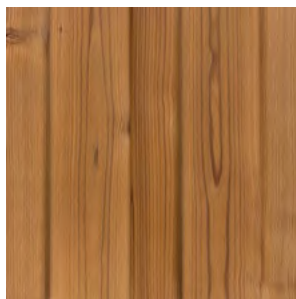

Thermowood Fir
Walls, benches, ceiling in thermowood fir

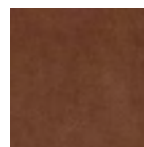

Terracotta Gres

Cladding of wall behind the stove and internal/external flooring in Terracotta gres porcelain



Carbon Gres

Cladding of wall behind the stove and internal/external flooring in Carbon gres porcelain

NATURE SAUNA PERSONAL



External cladding



Savublack Fir
External cladding in
black-waxed fir

Internal cladding



SavublackFir
Walls, benches, ceiling

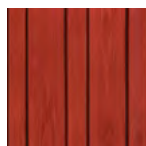

Terracotta Fir
Walls, benches, ceiling

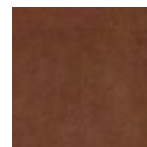

Terracotta Gres
Cladding of wall behind the stove
and internal/external flooring in
Terracotta gres porcelain

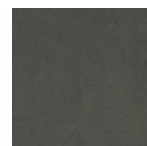

Carbon Gres
Cladding of wall behind the stove
and internal/external flooring in
Carbon gres porcelain

NATURE SAUNA PERSONAL



External cladding



Blue Fir
External cladding

Internal cladding



Terracotta Fir
Walls, benches, ceiling

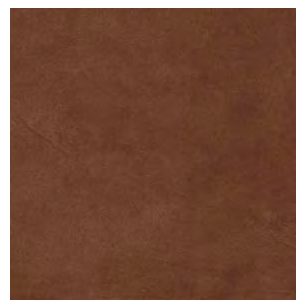

Terracotta Gres
Cladding of wall behind the stove and internal/ external flooring in Terracotta gres porcelain

NATURE SAUNA PERSONAL



External cladding



White Fir
External cladding

Internal cladding



Terracotta Fir
Walls, benches, ceiling

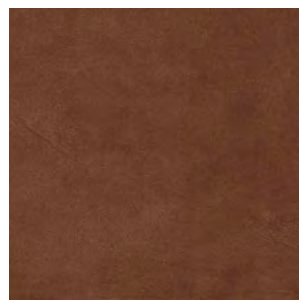

Terracotta Gres
Cladding of wall behind the stove and internal/ external flooring in Terracotta gres porcelain

Technical data

External dimensions (cm)	230 w x 250 d x 217/257 h
Sauna dimensions (cm)	200 w x 186 d x 186/214 h
Voltage	400 Vac 3P+N+Pe
Maximum consumption (kW)	7,3
Technical specification	Finnish Sauna
Temperature	90 - 100 °C
Humidity	10 - 20%
Heating inside the cabin	Electric stove
Lighting inside the sauna	2700°K white led-light bar placed under the benches and behind the backrest
Music kit	Brain Training programs available with My W-Place app by Starpool loudspeakers installed under the upper bench
Frame / Door	Double-glazed (6/18/6) front glass wall with electro-coloured aluminium frame
Door handle	External handle in black steel 316L Internal handle in the same wood as internal cladding Handle height: 98 cm / square section: 30x30 cm
Structure	Self-bearing wooden structure, mountable on site (minimum thickness 15 cm, U=0,25W/sqmK)
Snow load	300 Kg/sqm

Functions

ON / OFF	Through remote Touch-screen display or My W-Place app
Lighting	Through remote Touch-screen display or My W-Place app
Sound diffuser + Music	Through remote Touch-screen display or My W-Place app
Alarm	Through button inside sauna

Layout

Layout B

plan

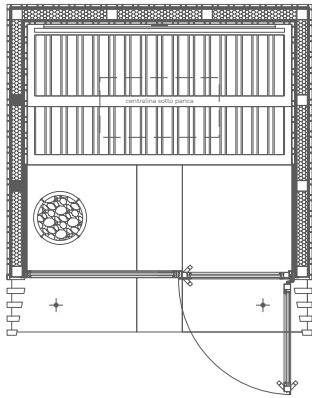

side view

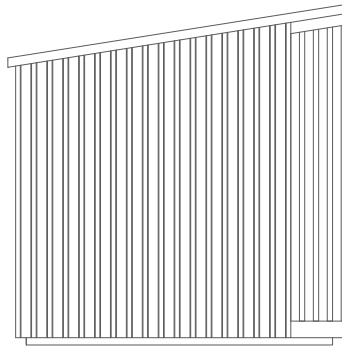





*Smart
Technology*

Smart Technology

Sustainable products and technologically performing systems contribute to defining the quality standard of each activity.

We develop software systems that allow to reduce our products' energy consumption, as well as improve and automate their functions. Technology in the service of our clients that increases connectivity to a computer network which is more and more sophisticated and, at the same time, user-friendly.



The remote **management** of our every realisation, ranging from the room temperature parameters to the scheduling of the switching on and off of the cabin, **as well as predictive maintenance, ensure constant consumption monitoring and optimization of operating costs.**

To make wellness more and more accessible and smart.



[Discover more on our technological solutions and innovations](#)

SMART TECHNOLOGY

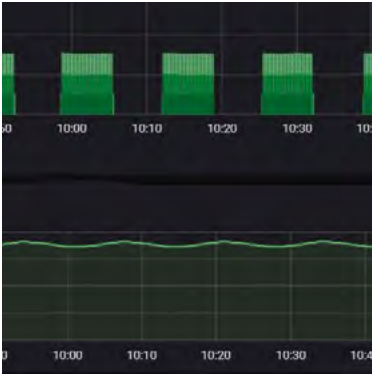

GREEN PACK

Our Research & Development department developed a system to improve the functions of our products. By installing Green Pack, it is possible to **reduce energy consumption** thanks to **smart detectors** that prevent needless steam leakage, control the heat and humidity of the environment, and maintain a constant temperature through the energy load management. **A sophisticated system that allows an average 20% energy saving.**



ECO SPA TECHNOLOGY

An innovative control system to bring together all our product devices. **It is a management software, installed in each one of our products**, that allows to measure constantly and in real time the fundamental parameters of the equipment. **Monitoring and automated management, remote diagnostics, and optimization of energy loads distribution** through a practical touch-screen display.

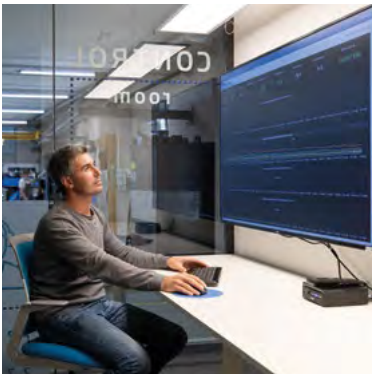

SIM 4.0

Telemetry of each installed spa product, a software that allows **to constantly measure the essential parameters of the equipment**. It monitors the usage of the products, detects any drop in performance, as well as anomalies and alarms. It controls the energy load in real time, so that it is possible to intervene before the problem occurs. **Its Business Intelligence provides a report** showing the spa performance, the guests' preferences, and the equipment energy consumption, in order to favour optimum management of the spa.



MY W-PLACE

We believe that technology has the power to improve many aspects of every-day life. This is why we created **My W-Place, our intuitive, practical, complete app**, which offers **valuable support in managing your spa remotely** and improves the wellness experience with a number of quality contents, such as **Mindfulness and guided breathing programs, music, and the latest news from the world of Wellness.**

STARPOOL

wellness concept



AmstelConcepts BV

Assumburg 152 B

1081 GC Amsterdam,

The Netherlands

+31 20 6693560

info@amstelconcepts.com