

STARPOOL

w e l l n e s s c o n c e p t

RelaxCollection



**WELCOME
TO A NEW
DIMENSION
OF SPA**







DNA STARPOOL

Paths and treatments that make use of heat, water and relaxation.

“This formula, with its ancient origins, is the true essence of every Starpool spa. We express our passion for the culture of well-being through the design and constant search for quality of our products and services.”

A handwritten signature in black ink, reading 'Riccardo Turri'.

Riccardo Turri
CEO Starpool



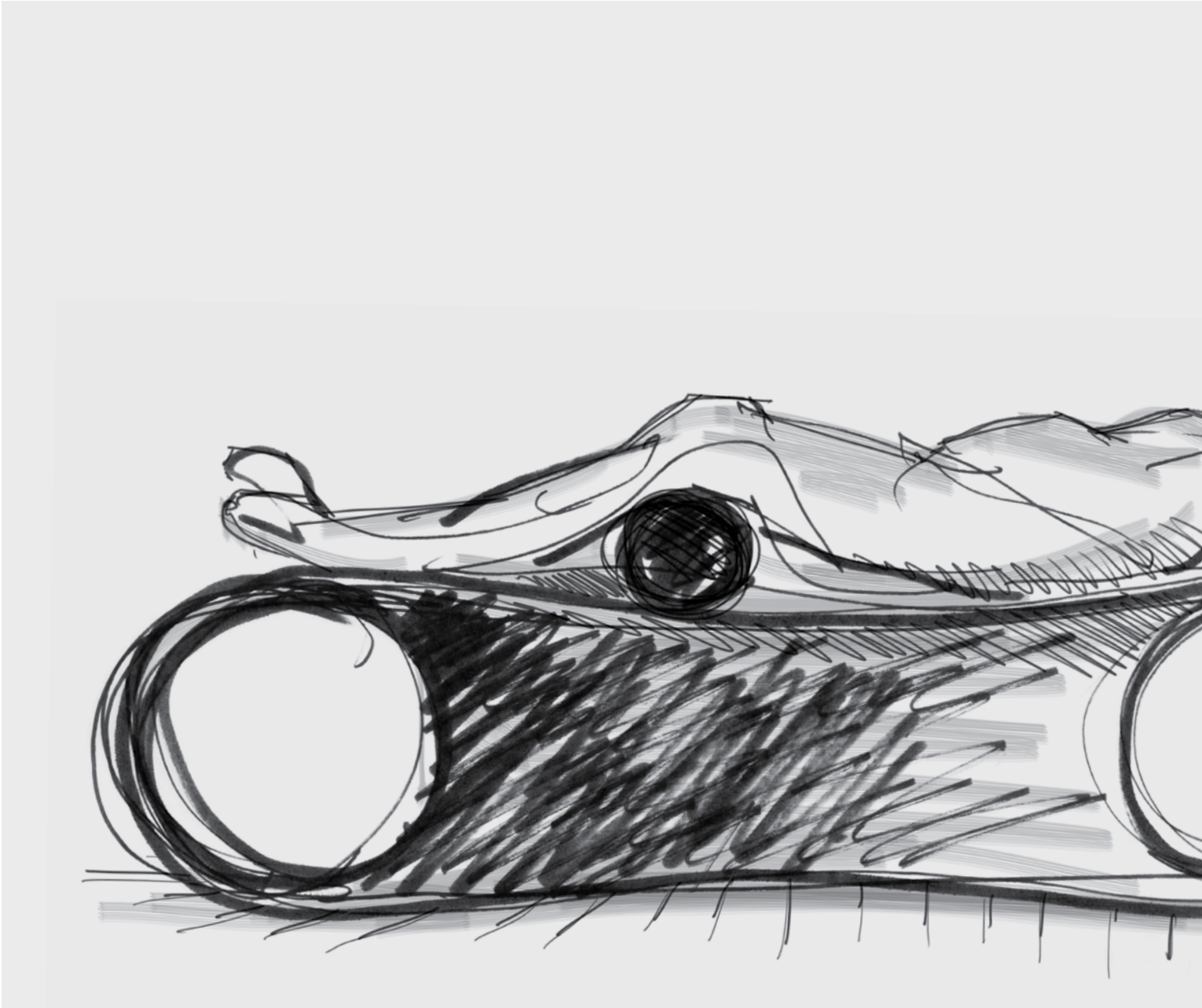

All products in the Relax Collection have been planned by Starpool.





RELAX COLLECTION IS

Ergonomic, sleek lines, naturally inspired materials and an eye for detail: these are the main characteristics of Starpool's range of products dedicated to relaxation.

The forms follow the lines of the body, turning rest into a moment of true well-being. The choice of coverings and fabrics ensures the highest levels of comfort.

The Relax Collection ensures that well-being is not the exclusive right of hotels or fitness centres, but can also be part of daily home life.



The Relax product range

Designed for Starpool by the renowned designers of Made in Italy, these loungers are stylish items of furniture for fitness centres, spas and private homes, combining classic and contemporary taste. The functional design offers differing technical performances, while the vast range of fabrics and colours means that Starpool loungers will fit into any type of ambience.

Relax Collection



Starlongue

08



StarLit

14



DayBed

20



Bridge

26



Synua

32



SweetChair

38

Coverings

44

Starlongue

Design Studio Bizzarro & Partners

**INDULGE IN
SOOTHING
RELAXATION**

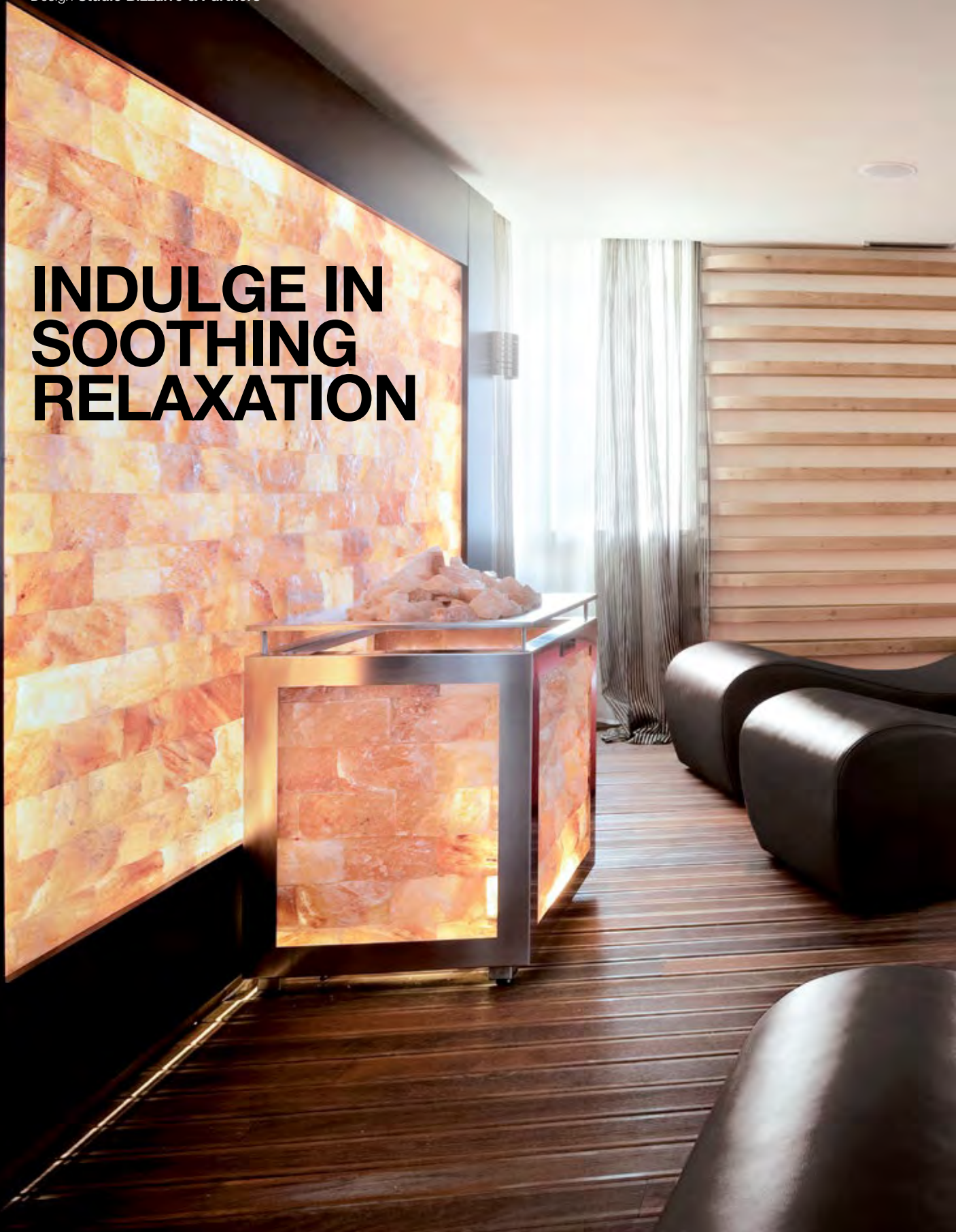

Starlongue



A SOFT EMBRACE

A chaise longue in which to relax, read or meditate.

Enveloping and ergonomic, Starlongue has been designed to ensure perfect rest. Its rounded, sinuous forms hold the body in a soft embrace, while its dynamic, sleek design is further emphasised by elegant coverings, embellished with visible stitching, providing these loungers with versatility and adaptability for every ambience and style.



FUNCTIONAL DESIGN



1_ SINOUS FORM

The ergonomic form of Starlongue guarantees optimal adhesion of the body: the legs remain raised with the knees slightly above the height of the heart, thus stimulating the circulation.

2_ SLIP-RESISTANT SUPPORTS

The structure is supported by four invisible anti-slip supports to guarantee perfect stability.

3_ HIGH-QUALITY STITCHING AND FABRICS

The high-quality finishes with seams delineating the outlines lend the fabric maximum stability and durability. The quality of the coverings meets the highest standards.

LIGHTWEIGHT AND EASY TO CARRY

Sturdy and stable, yet thanks to its wooden frame very light: filled with non-deformable polyurethane foam covered in padded Dacron.

TECHNICAL SPECIFICATION

DIMENSIONS (cm)	190 L x 70 W x 70 H / 32 Hs
STRUCTURE	Plywood with anti-slip feet (h 2 cm)
SEAT	Filling of non-deformable polyurethane foam covered in padded Dacron
WEIGHT	26 Kg
USE	Indoor

Starlongue

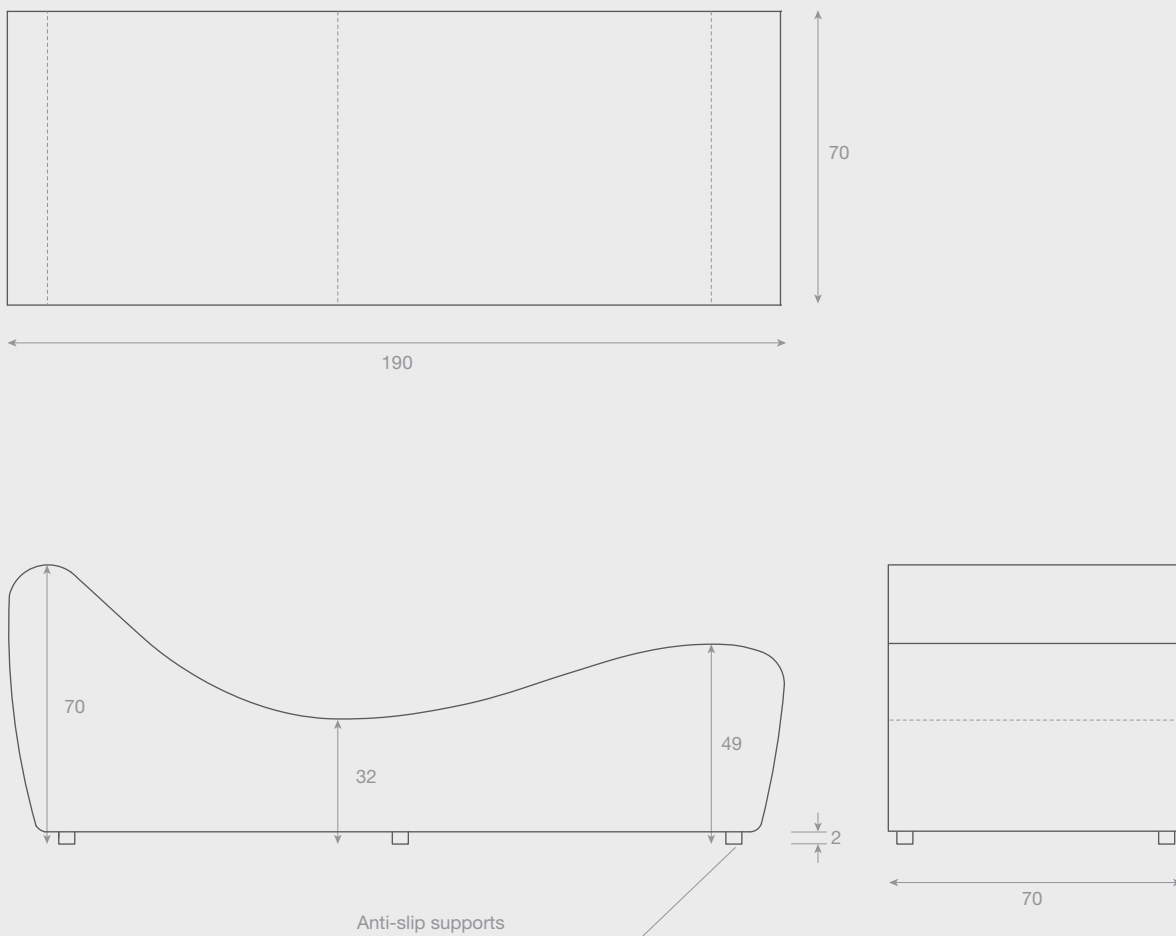

StarLit

Design **Baldessari e Baldessari**

WHEN HISTORY MEETS DESIGN





StarLit



PURE ELEGANCE

StarLit is distinguished by the softness of its lines and the strength of its ideas. The design offers a reinterpretation of the classic “dormeuses” of the bedrooms and parlours of the noble residences of the 18th century: these special divans were already in use in Roman times, not just for rest but also as seating at lunch and dinner times. As well as being extremely versatile, StarLit becomes an item of furniture that adds elegance to its surroundings.



FUNCTIONAL DESIGN

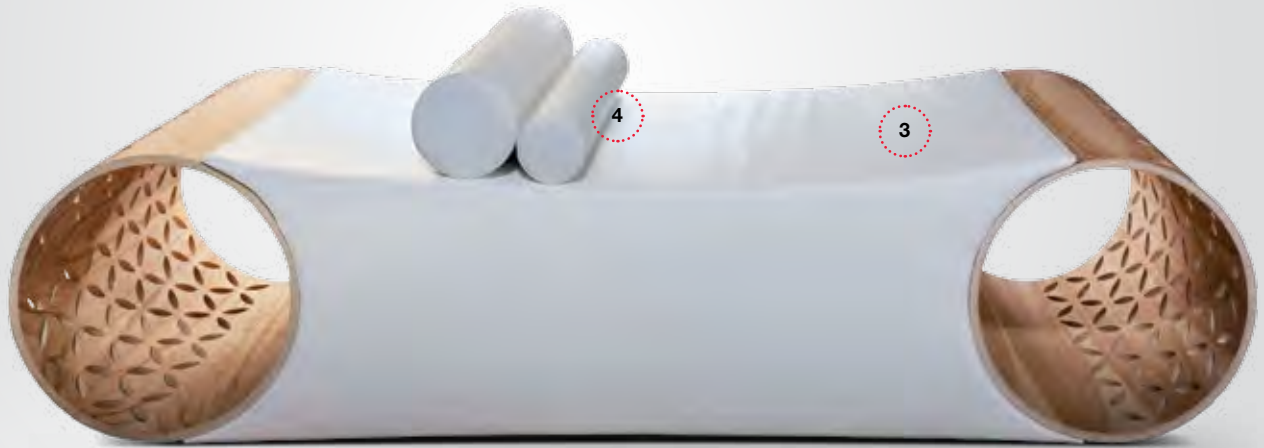

1 SPACE-SAVING CYLINDER

Aesthetics combined with outstanding functionality.

The two cylinders contain the cushions and at the same time can save space with room for slippers, bags and towels.

2 ELEGANT FRETWORK

The precious olive wood is further emphasised by the elegant fretwork that recalls the line of the leaves. With its almost golden tones streaked with a rich brown, olive is a hard wood, compact and homogenous, resistant to woodworm and ideal for the manufacture of fine furniture.

3 COMFORTABLE FILLING AND COATINGS

Sturdy and stable, StarLit is also very comfortable thanks to its polyurethane foam filling with visible seams that ensure high stability for the fabric covering.

4 HEADREST AND LEGREST

The two cylindrical cushions have different diameters to maximise user comfort: the neck and legs are supported at two different heights that can be changed according to individual needs.

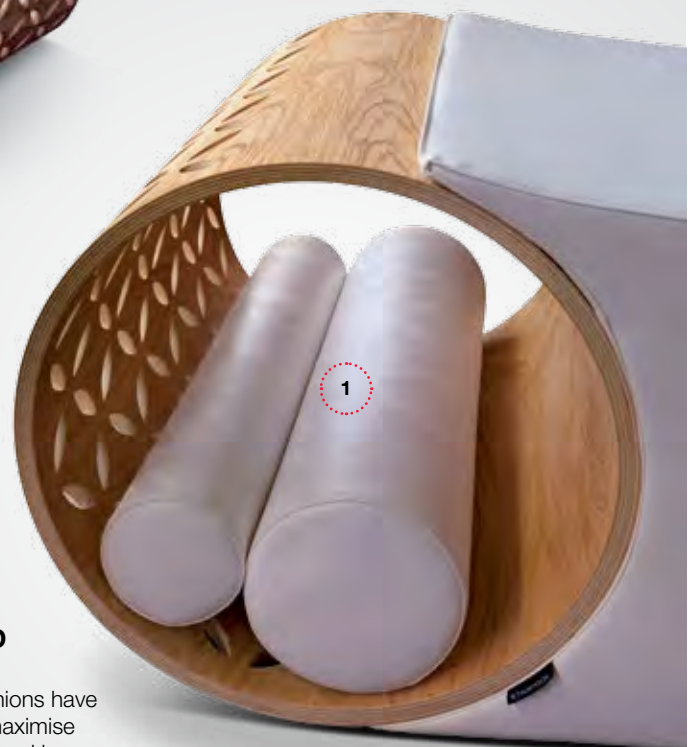

TECHNICAL SPECIFICATION

DIMENSIONS (cm)	206 L x 65 W x 48 H / 40 Hs
STRUCTURE	Plywood with steel feet (h 1 cm)
CYLINDER	Curved plywood, diameter 45 cm, thickness 19 mm, veneered on both sides with olive wood
SEAT	Filling of high-density polyurethane foam covered with padded Dacron
WEIGHT	44 Kg
USE	Indoor

Accessories supplied: cushion for head / cushion for legs

StarLit

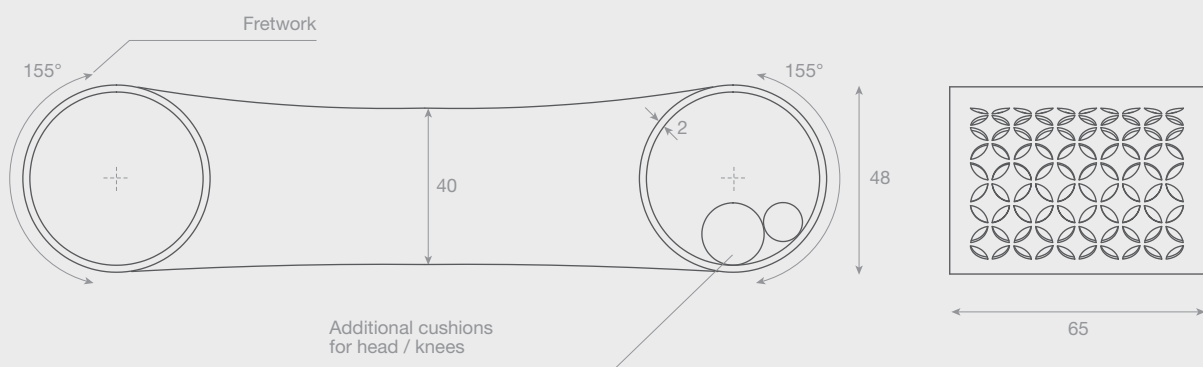

DayBed

Design Cipiuelle Architecture and Interior Design

**RELAX
YOURSELF**

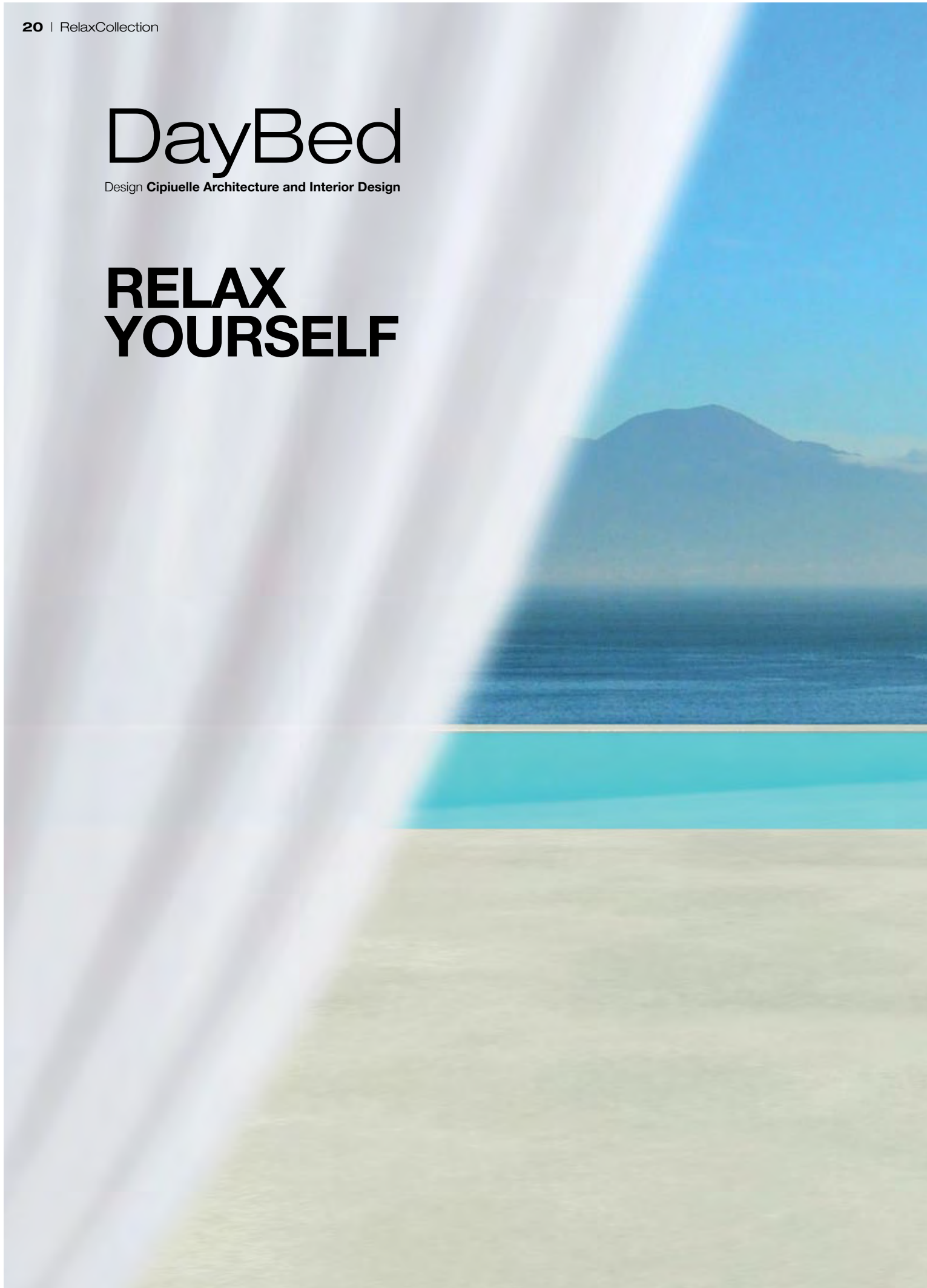



DayBed



COMBINING LIVING AND BEDDING

DayBed is simple and sleek. The high quality of fabrics and finishings combine in a language of clean lines of the oak structure, which offers free space for the enveloping comfort of the mattress. A timeless style and identity suited to any surroundings, providing a pleasant opportunity for healing relaxation.



FUNCTIONAL DESIGN

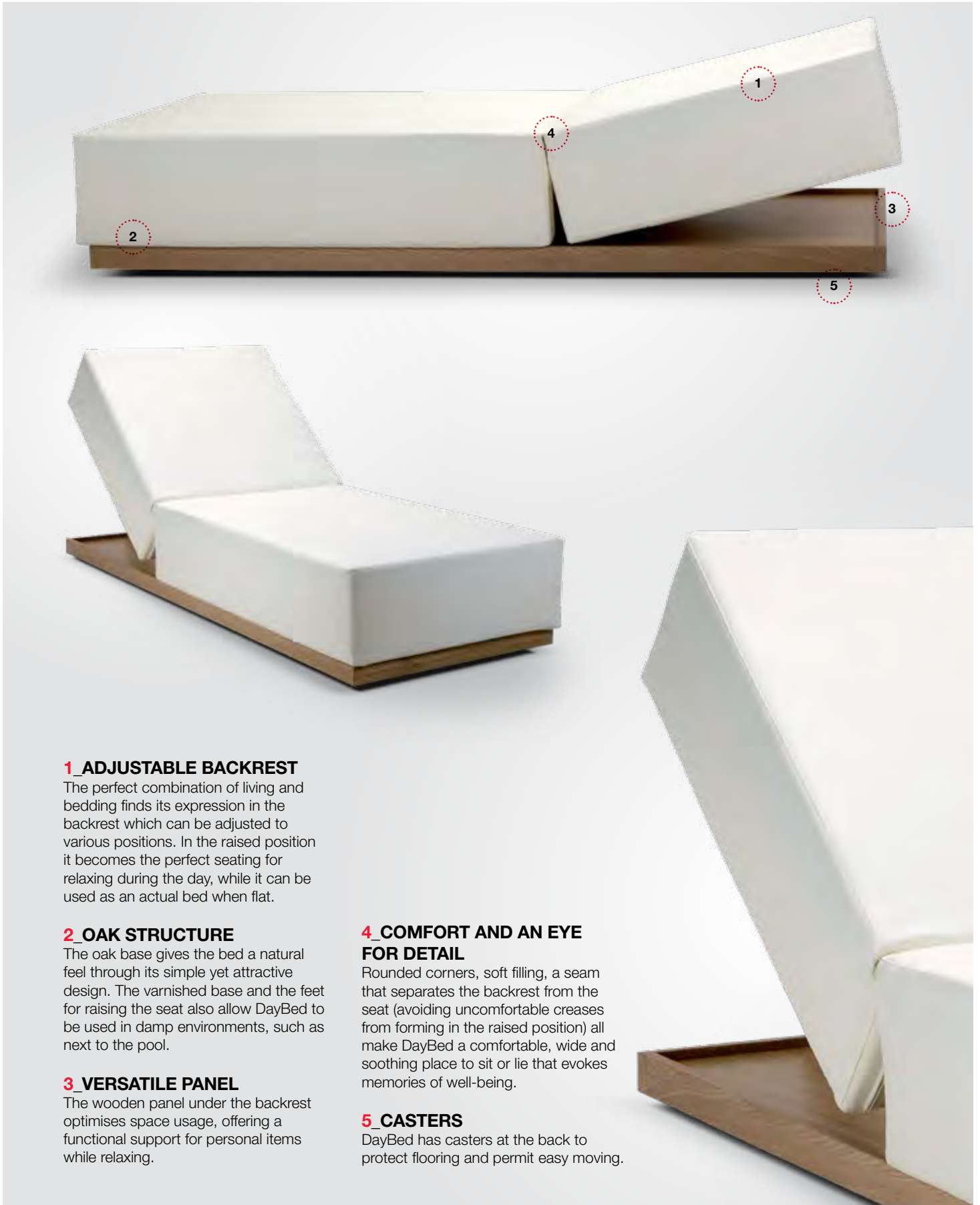

1_ ADJUSTABLE BACKREST

The perfect combination of living and bedding finds its expression in the backrest which can be adjusted to various positions. In the raised position it becomes the perfect seating for relaxing during the day, while it can be used as an actual bed when flat.

2_ OAK STRUCTURE

The oak base gives the bed a natural feel through its simple yet attractive design. The varnished base and the feet for raising the seat also allow DayBed to be used in damp environments, such as next to the pool.

3_ VERSATILE PANEL

The wooden panel under the backrest optimises space usage, offering a functional support for personal items while relaxing.

4_ COMFORT AND AN EYE FOR DETAIL

Rounded corners, soft filling, a seam that separates the backrest from the seat (avoiding uncomfortable creases from forming in the raised position) all make DayBed a comfortable, wide and soothing place to sit or lie that evokes memories of well-being.

5_ CASTERS

DayBed has casters at the back to protect flooring and permit easy moving.

TECHNICAL SPECIFICATION

DIMENSIONS (cm)	200 L x 80 W x 80 H / 33,5 Hs
STRUCTURE	Natural oak
BASE	Marine plywood base, oak veneer with waterproof coating, adjustable steel front legs, rear casters for moving bed
SEAT	Filling in polyurethane foam mattress covered in removable fabric
WEIGHT	59 Kg
USE	Indoor

Optional: topper (available coverings on page 44)

DayBed

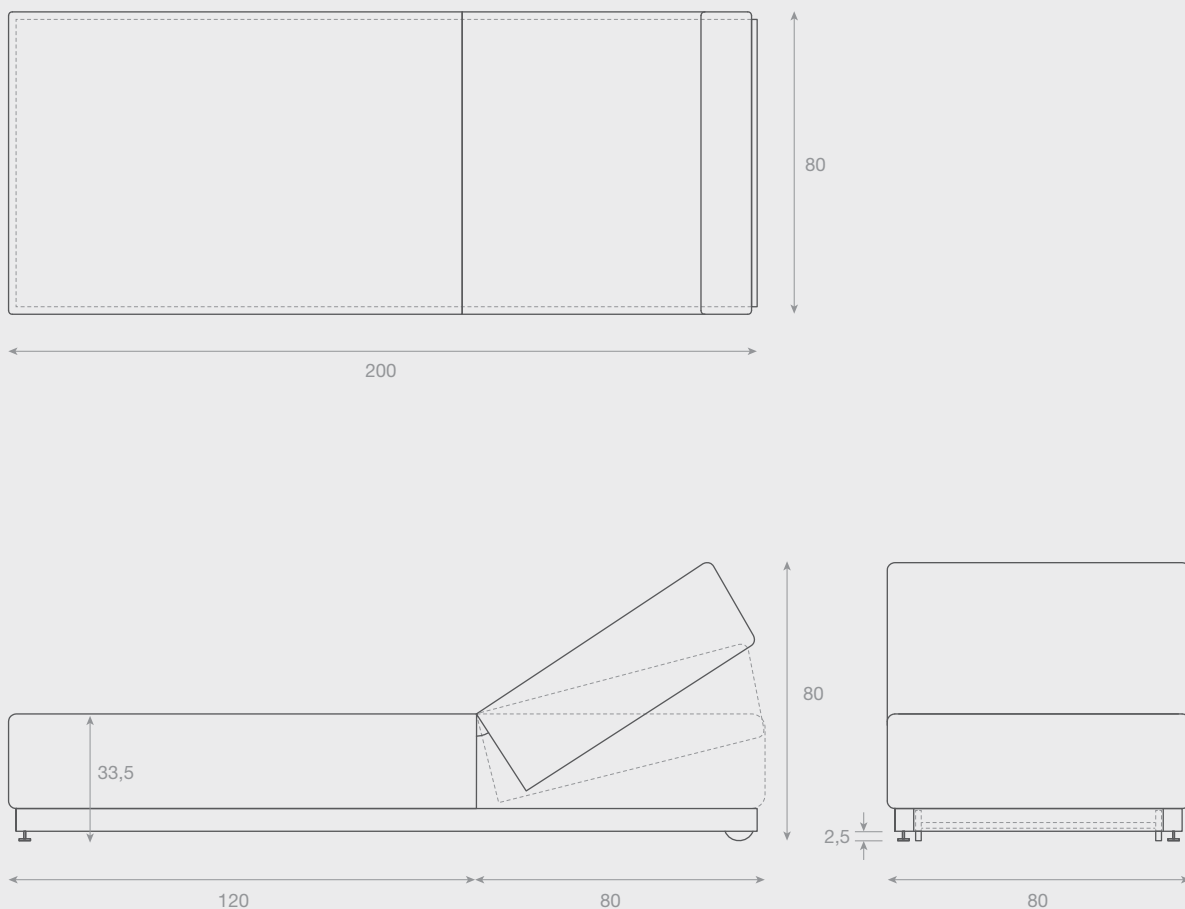

All coverings available on page 44

Bridge

Design Luca Scacchetti

THE ESSENTIAL PURITY OF FORM





Bridge



SLENDER FORMS

Sleek design and a rich personality for a lounger that gratifies both body and surroundings. Designed with a soft and anatomical line that is a comfortable place to stretch the body with discretion and elegance. The softness of the seat contrasts with the linearity of the oak wood base, conveying lightness and harmony of proportion. Its minimal design is a perfect synthesis of cleanliness, comfort and refinement.



FUNCTIONAL DESIGN

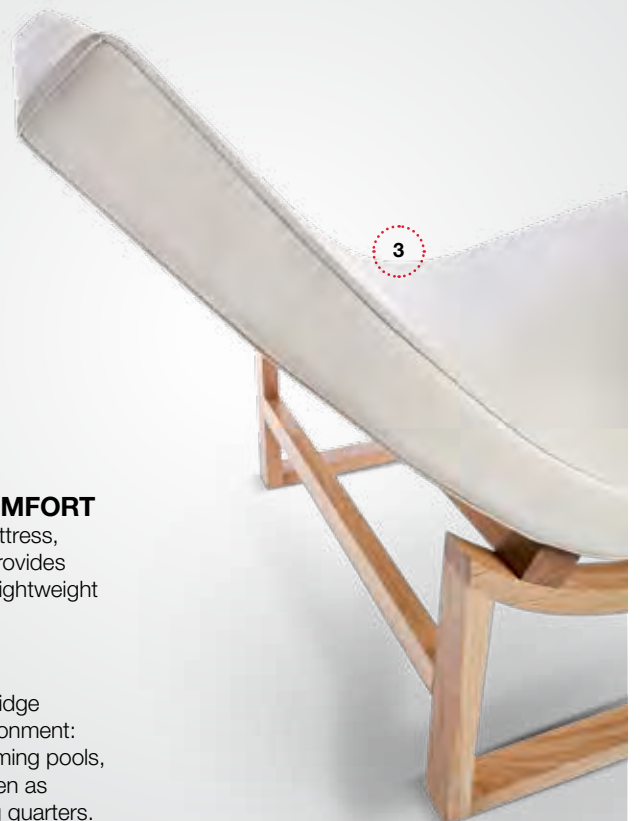

1_ ABSOLUTE SIMPLICITY

The minimal and elegant lines of the whole consist of a single, sinuous surface for the seat and a solid, non-obtrusive base for the structure.

2_ DURABILITY AND STABILITY

Two superimposed forms, distinct and visually separate, are connected by robust joints to ensure maximum stability and durability.

3_ LIGHTNESS AND COMFORT

A slender yet comfortable mattress, no more than the essential, provides maximum comfort. Bridge is lightweight and easy to carry.

FITS ANYWHERE

The enormous versatility of Bridge makes it suitable for any environment: spas, wellness centres, swimming pools, home relaxation areas and even as furnishing for living or sleeping quarters.

TECHNICAL SPECIFICATION

DIMENSIONS (cm)	162 L x 72 W x 85 H / 37 Hs
STRUCTURE	Curved plywood
BASE	Solid natural varnished oak using varnish that is highly resistant to atmospheric agents
SEAT	Filling of high-density polyurethane foam covered with padded Dacron
WEIGHT	20 Kg
USE	Indoor

Bridge

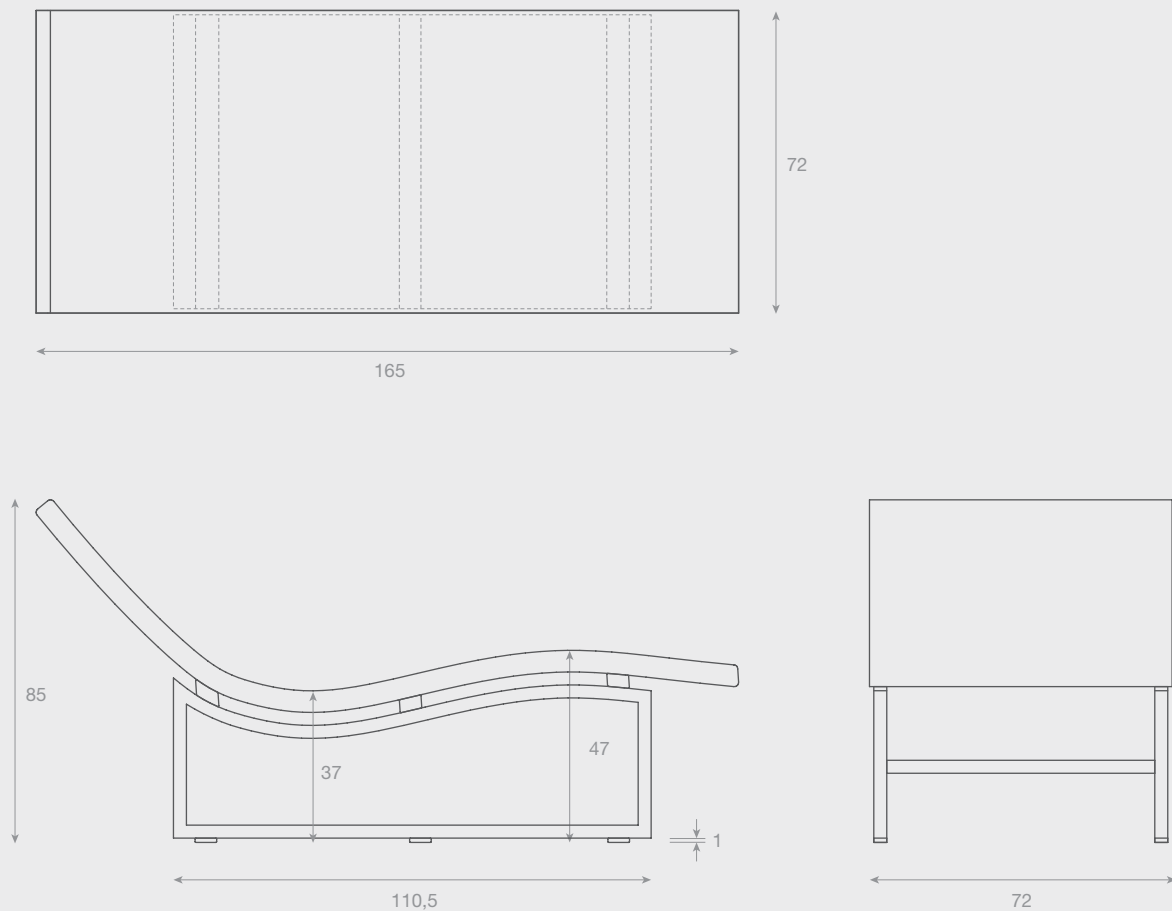

Synua

Design Cipiuelle Architecture and Interior Design

**HARMONIOUS,
SUPPLE REST**



Synua



SINUOUSLY COMFORTABLE

With its elegant lines, Synua is designed for complete relaxation with harmonious proportions, carefully calibrated, and an enveloping backrest and soft cushion headrest. The base, of oak, gives character and style to the whole. Available in leather or fabric, it will make the idea of rest more attractive still.



FUNCTIONAL DESIGN



1_ IDEAL ERGONOMICS

The ergonomic, sinuous, shape of Synua – hence the name – ensures optimum adherence of the body and denotes its versatile character, the result of careful, formal research that guarantees the best possible comfort.

2_ OAK AND ALUMINIUM STRUCTURE

The simple, elegant base of natural oak or wenge-tinted oak is connected to a polished aluminium bar that gives the seat a marked air of determination.

3_ HEADREST

The cushioned headrest can be adjusted in height and has been designed to improve posture while resting or to facilitate reading while relaxing.

4_ FILLING AND COVERING

The soft polyurethane foam filling covered in padded Dacron and the highest quality fabrics make this chaise longue the ideal place to indulge in the most absolute peace and tranquillity.

TECHNICAL SPECIFICATION

DIMENSIONS (cm)	180 L x 63 W x 90 H / 42 Hs
STRUCTURE	Plywood
BASE (*)	Veneered plywood in natural varnished oak or wenge-tinted oak using varnish that is highly resistant to atmospheric agents with aluminium support bar
SEAT	Filling of high-density polyurethane foam covered with padded Dacron
WEIGHT	42 Kg
UTILIZZO	Indoor

Accessories supplied: height-adjustable headrest cushion (*)



Oak color wengè

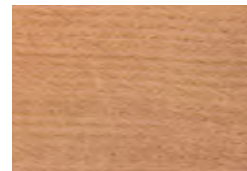

Natural oak

Synua

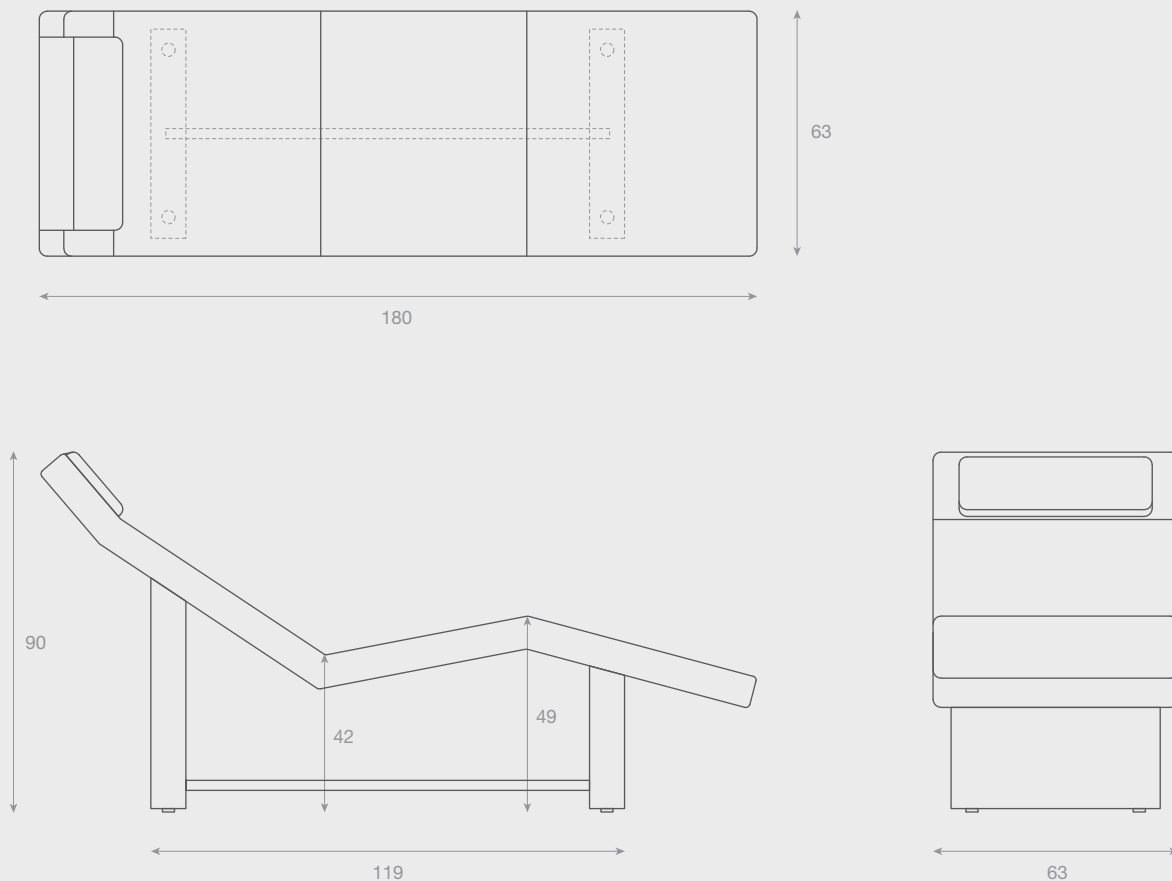

All coverings available on page 44

SweetChair

Design Fabio Alemanno

THE SHAPE OF WARMTH





SweetChair



MARBLED REST

The unique structure of SweetChair provides a seat that combines design and technology. The precise ergonomics and extreme versatility of SweetChair make it the ideal choice for either professional or home use. You only need a moment to appreciate the comfort offered: a fully adjustable reclining backrest and heated marble slab to produce an unforgettable sensation of relaxation.

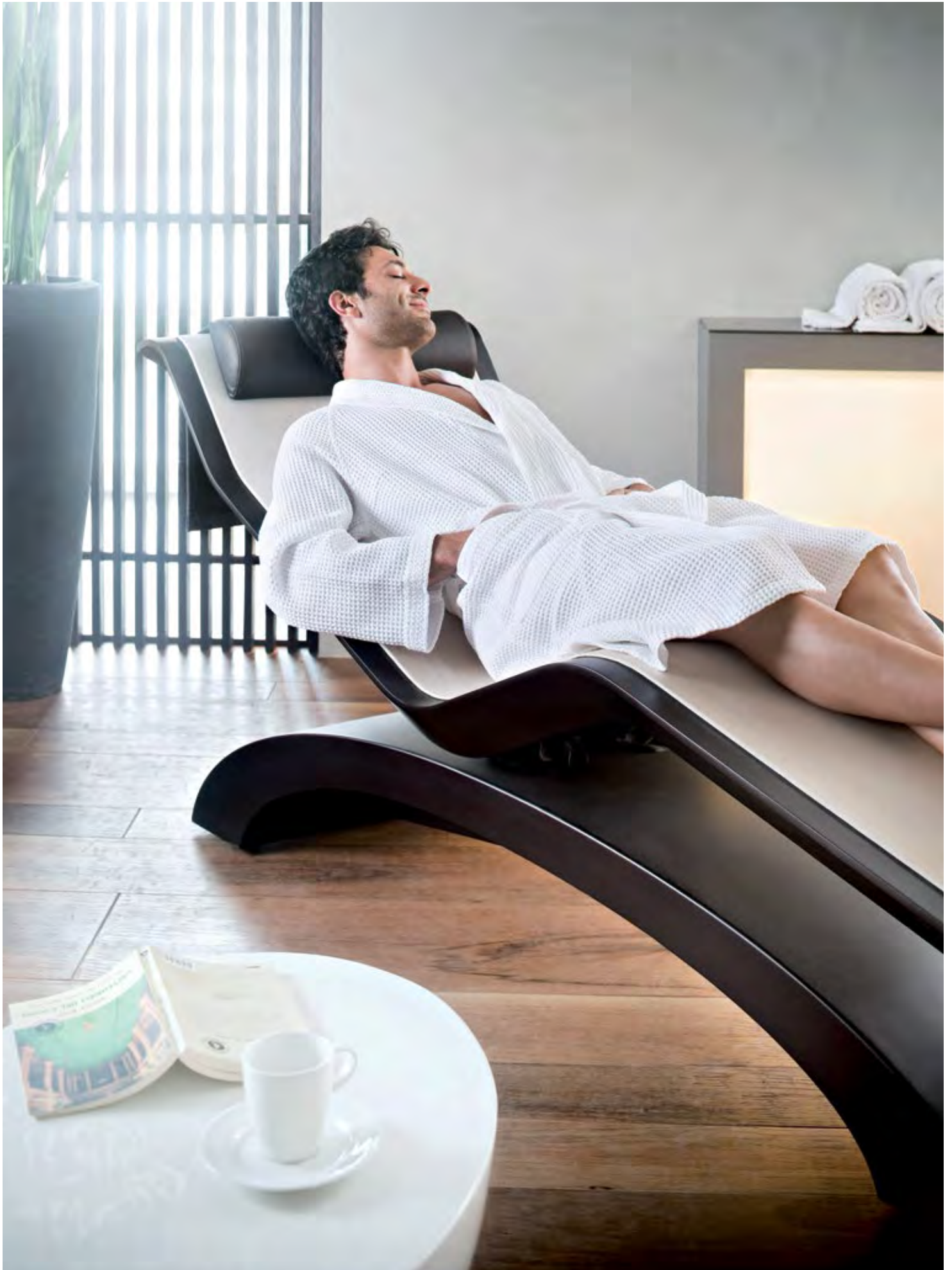

FUNCTIONAL DESIGN



1_ INFRARED TO PRODUCE A SENSATION OF ENVELOPING WARMTH

SweetChair has an infrared heating system as standard that releases and transfers heat over the entire surface of the stone.

2_ DIGITAL THERMOSTAT

The digital thermostat can regulate the temperature up to 41.5° C, transforming the smooth and silky surface of the marble into an alcove of perfect rest.

3_ WATERPROOF STRUCTURE

The waterproof structure of this chaise longue makes it suitable for indoor and outdoor use even in particularly damp locations.

4_ LEATHER HEADREST

With its soft leather headrest, SweetChair becomes the ideal bed for indulging in warm, comfortable rest.

5_ CASTERS

SweetChair has casters to protect flooring and permit easy moving.

6_ RECLINER BUTTONS

Automatic full adjustment of the seat angle allows everyone to find their ideal position for relaxing or reading (optional feature).

TECHNICAL SPECIFICATION

DIMENSIONS (cm)	193 L x 68 W x 83,5 H / 42 Hs
STRUCTURE	Rust-resistant steel
STRUCTURE COVERING	Water-resistant glass fibre with metallic black paintwork
SEAT	Single marble slab
WEIGHT	190 Kg
TEMPERATURE	Up to 41,5° C with infrared emission system
HEATED SURFACE	Total surface heated as standard via a single sensor
INSTALLATION REQUIREMENTS	16A earthed plug
CONSUMPTION REQUIRED TO HEAT BED	220-240V/800W - 110-120V/950W
DIGITAL THERMOSTAT	Can regulate temperature up to 41,5°C
USE	Indoor / outdoor

VERSIONS

Lime Stone
Cod. 601



Nero Marquina
Cod. 602



Calacatta
Cod. 603



Eramosa
Cod. 604



Headrest cushion included. **Options:**

1) Recliner buttons for automatic full adjustment of seat angle

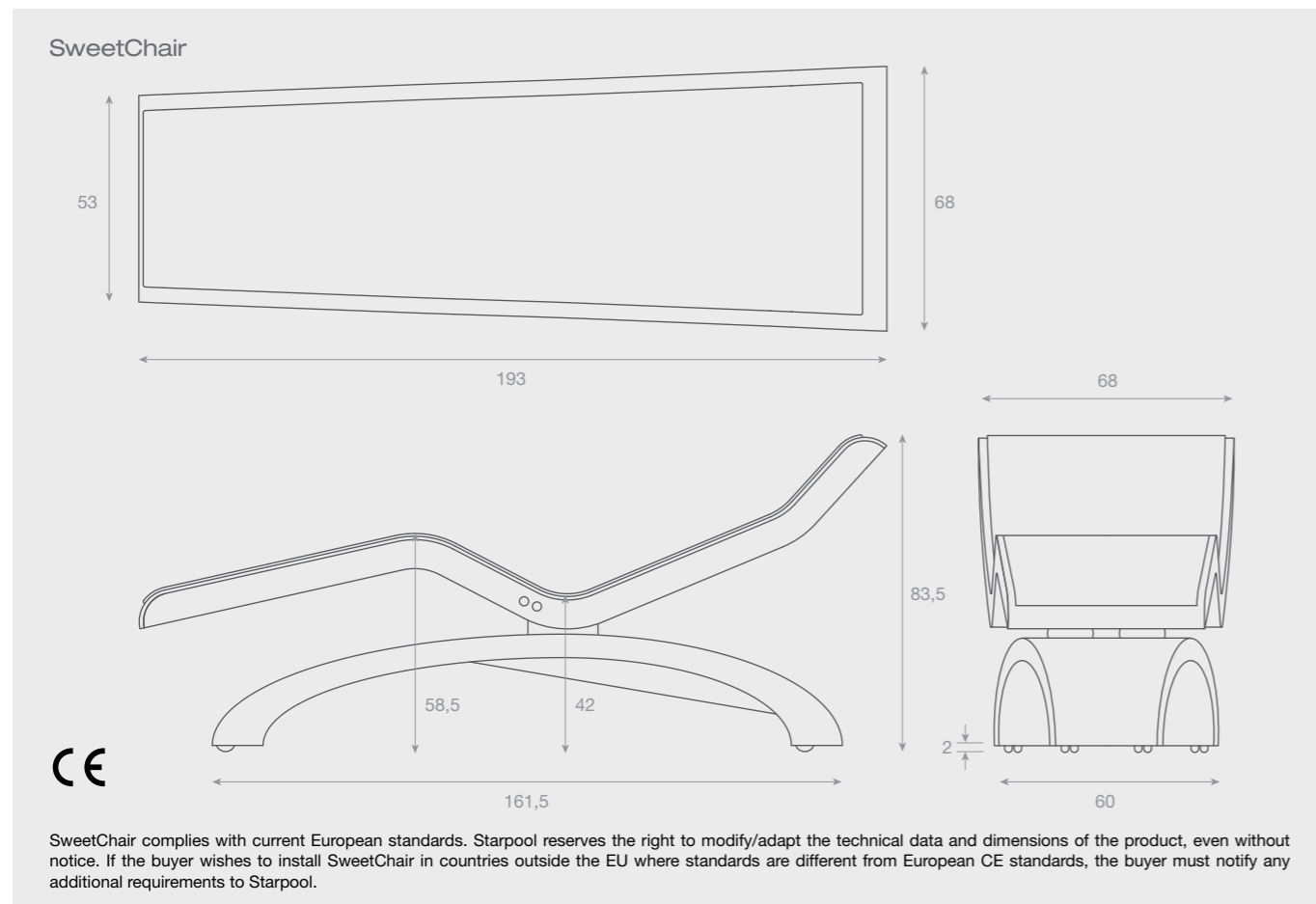











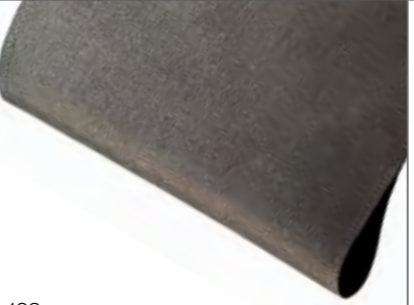
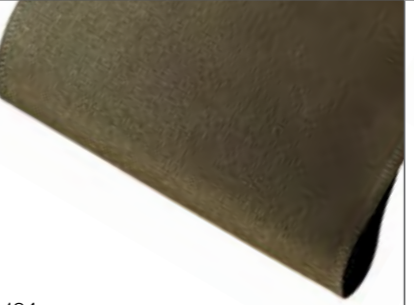
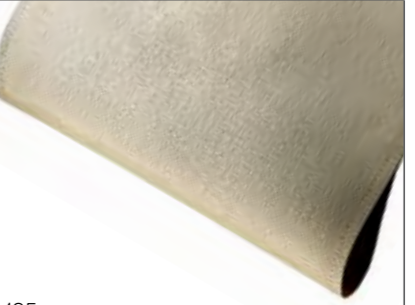

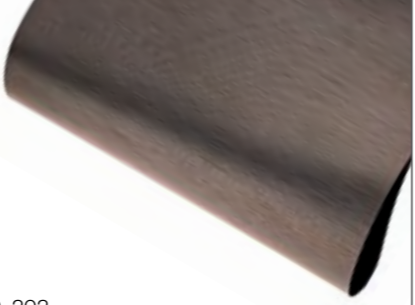
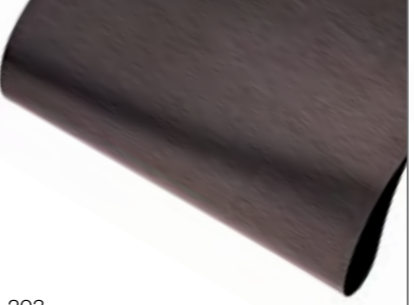
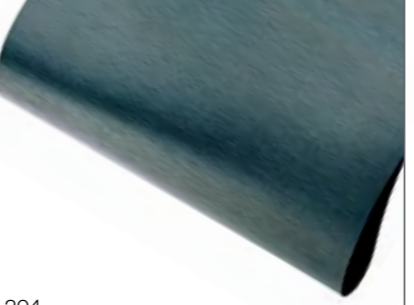
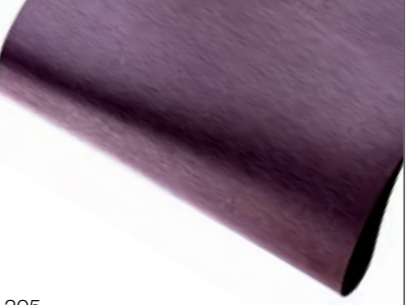
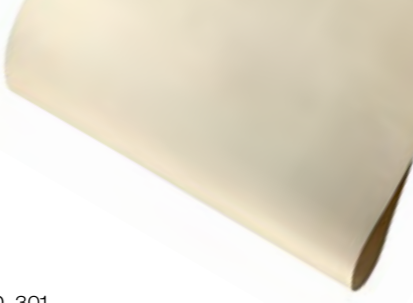
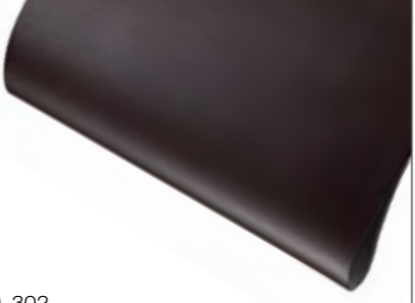
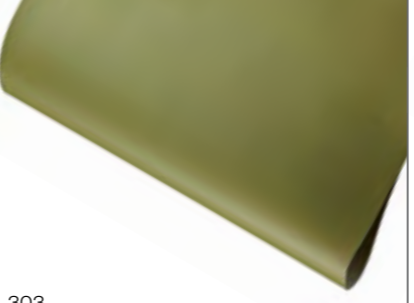
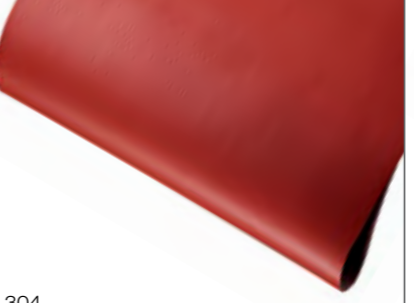
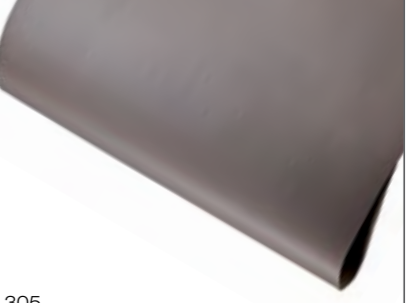

COOL
VE
BRIN
GS

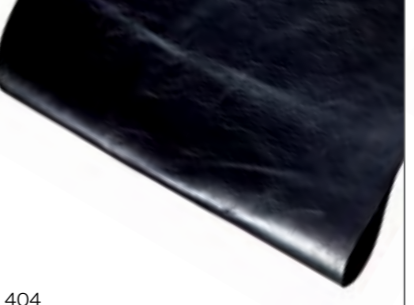

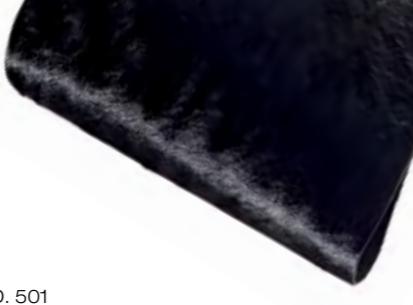
COVERINGS

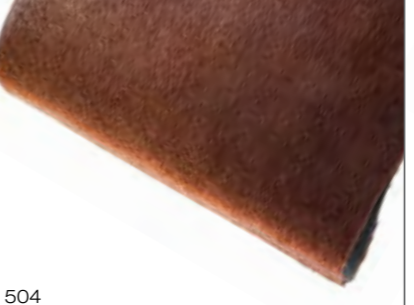
Starlongue | StarLit | DayBed | Bridge | Synua

<p>PLOT</p>	<p>DARK GREY COD. 101</p> 	<p>GRAPE COD. 102</p> 	<p>BLUE GREY COD. 103</p> 	<p>OLIVE GREEN COD. 104</p> 	<p>BEIGE COD. 105</p> 
<p>SUDDEN</p>	<p>METALLIC GREY COD. 201</p> 	<p>METALLIC MUD COD. 202</p> 	<p>METALLIC CHOCOLATE COD. 203</p> 	<p>METALLIC OIL COD. 204</p> 	<p>METALLIC PLUM COD. 205</p> 
<p>SKY</p>	<p>OFF WHITE COD. 301</p> 	<p>DARK BROWN COD. 302</p> 	<p>PISTACHIO GREEN COD. 303</p> 	<p>BRICK COD. 304</p> 	<p>DOVE GREY COD. 305</p> 
<p>REAL LEATHER</p>	<p>DARK MUSTARD COD. 401</p> 	<p>BURNT EARTH COD. 402</p> 	<p>MILITARY GREEN COD. 403</p> 	<p>BLACK COD. 404</p> 	<p>ICE GREY COD. 405</p> 
<p>CAVALLINO</p>	<p>BLACK COD. 501</p> 	<p>HAZELNUT COD. 502</p> 	<p>OIL GREEN COD. 503</p> 	<p>RUST COD. 504</p> 	<p>DAPPLED COD. 505</p> 

N.B.: colours are purely representative and actual fabric may appear different from printed image. See RelaxTiling for the best view of type of texture and colour.

HOW TO FIND STARPOOL

AmstelConcepts BV

P.O. Box 69409, 1060 CL

Amsterdam, The Netherlands

+31 20 6693560

mhorn@amstelconcepts.com

**OVER 1,600 SPA PROJECTS AROUND
THE WORLD
OVER 300 HOMES FURNISHED WITH
STARPOOL PRODUCTS**

Starpool, Wellness Concept, Sweet, Mediterranean Bath, Rivestimento Milano, Rivestimento Cortina, Relax, Excite and Purify are all trademarks of Starpool s.r.l. and are registered in the countries of the European Union and worldwide. SweetProMed, SweetProSauna, SweetProSteam, SweetSpa, SweetSauna50, SweetSense, SweetSauna90, SweetSpa Eramosa and SpaTable are patents, models or filed patents of Starpool s.r.l. in the countries of the European Union and worldwide.

Starpool® reserves the right to change its products and literature without notice as part of its continuous process of product development and improvement.

Concept: Creativamente - Starpool • **Graphic design:** Creativamente (PD)
Copywriter: Marketing Starpool • **Photos:** Germano Borrelli • **Printing:** Litografia Editrice Saturnia (TN)

STARPOOL

wellness concept



AmstelConcepts BV

Assumburg 152 B

1081 GC Amsterdam,

The Netherlands

+31 20 6693560

info@amstelconcepts.com

