

STARPOOL

w e l l n e s s c o n c e p t

SoulCollection



www.starpool.com

**WELCOME
TO A NEW
DIMENSION
OF SPA**





STARPOOL'S DNA

Flows and treatments through
the use of heat, water and relaxation.

"This formula, with its ancient origins, is the true essence of every Starpool spa. We express our passion for the culture of well-being through the design and constant search for quality of our products and services".

Riccardo Turri
CEO Starpool



SOUL IS

Soul is the materiality of the coatings, distinct soft-to-the-touch textures, polychromatic ceramics, substances of great aesthetic impact such as black fir and glazed stoneware.

SoulSauna and SoulSteam are characterized by their pure lines plus ease of use and installation: two products whose contemporary design and urban, almost industrial style rekindle and update the most authentic soul of traditional well-being.

All products in the SoulCollection are overseen by designer **Cristiano Mino**

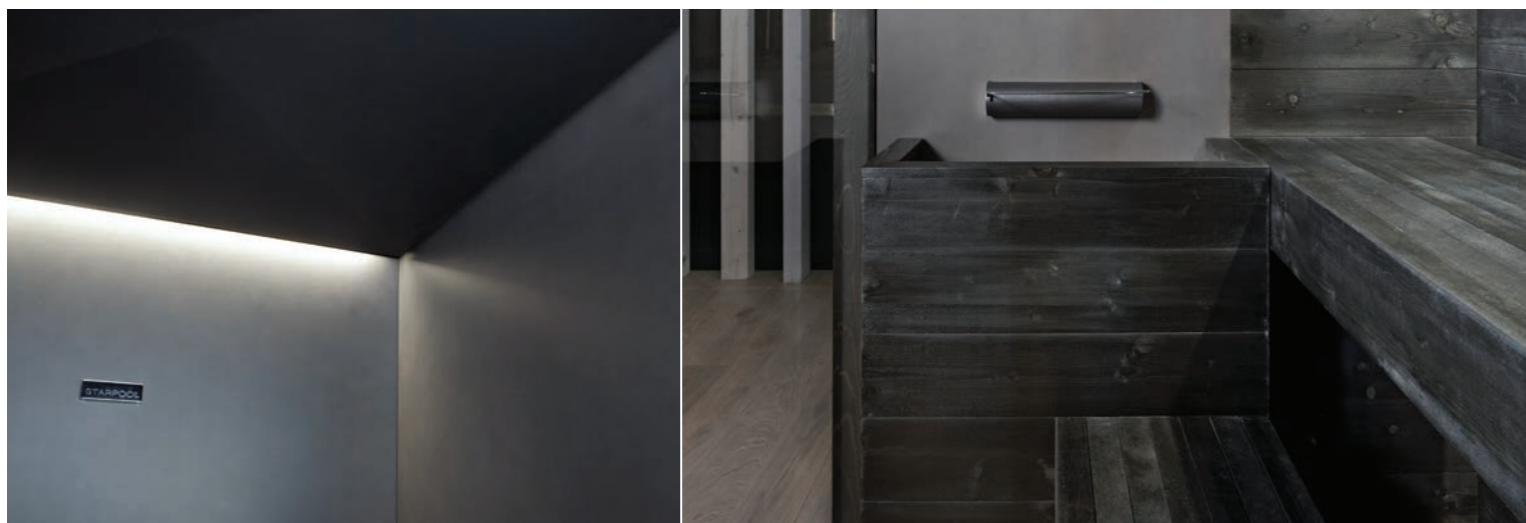



SOUL IS... GREEN

From the green heart of the Trentino Dolomites. It is here that Starpool draws inspiration for its work each day, a place where passion, innovation, belonging, skills and eco-sustainability guide the production of the companies whose roots are in this earth.

This means that "Be Green" is not just a slogan, but a real, constant and daily commitment to the future. Starpool believes in the added value of respect for the environment, which is why sustainability forms an integral part of all the company's activities.

Bio-compatibility

All Soul products are designed with eco-sustainability in mind. The sauna wood is 100% natural and is untreated. The special working of the slats and the construction system employed limits the use of adhesives in the installation phase, thus optimizing the healthiness of the surroundings.

Sustainable production

All Soul products are manufactured with a low environmental impact with limited energy consumption from clean and renewable sources, recyclable raw materials and external emissions equal to zero.

Renewable materials

Soul products are manufactured from highly recyclable materials that represent over 75% of their weight. The simple system for dismantling the components makes it easy to recover the raw materials at the end of a product's life-cycle.

Natural, reusable packaging

All Soul products are dispatched in firwood boxes from the Fiemme Valley that can be collected and re-used many times over, thus reducing the use of new packaging materials.

Let's make a difference!

At Starpool we sort waste materials and, where technically possible, we regenerate the components of products that have been withdrawn and are no longer in use.

GREEN TECHNOLOGY

We believe in the added value of the environmental-friendliness. For this reason, our products offer solutions to reduce the energy consumptions and to improve and automate their functions.



Green Pack

A software and a hardware that adjust and keep the temperature regular. Green Pack is connected to the self-closing doors and enables an about 20% energy saving during the standard operation by managing the energy load.

Touch Display

A software for the remote management of all Starpool's products. It sends a lot of functional information, alerts and check-ups to any mobile devices.

Eco Spa Technology

An easy-to-use software for the management and the automatized control of all Starpool's devices installed in a Spa. Useful for the remote diagnostics and the optimization of the energy loads. When you control the power distribution you avoid the overrun of the kW set to make the appliance work properly, for a long-term saving.

...switch my sauna on!



Google HOME



Assistente Google



amazon alexa

Control your smart Spa through the voice controls

Thanks to the devices like Google Home, Google Assistant and Alexa, now you can switch on and off and manage all the functions of all the Spa products through the voice control.

Be
green

Soul Collection



SoulSteam

12



SoulSauna

22

Colours of Soul

32

Comparative table

40

Layout

42

Create your own spa

44

Soul products

The two worlds of wellness par excellence, the sauna and the steam bath, are revived with notions of clean aesthetics and welcoming simplicity, all combined with the high technical quality of Starpool products. The careful choice of materials and components make true wellness ever more accessible and versatile: SoulSauna and SoulSteam can easily be used both in private residences and public spas, in ambiances that differ widely in terms of style.

SoulSteam

design Cristiano Mino

DESIGN PORTRAIT



SoulSteam



EACH TO THEIR OWN STYLE

The steam bath, the shower and the neck blade in SoulSteam blend together in the name of the utmost functionality, thanks to performing technologies and contained measures. The materiality of ceramics, with the particular velvet effect, in ivory and charcoal grey tones, gives sophisticated but versatile ambience at the same time. Combined with every type of chromatic palette, the neutral tones will take the same meanings of the surrounding colours and will make SoulSteam perfect to valorise the interior design of every ambience.



BE SIMPLY

Simplicity and practicality: comfort translated into user-friendly technology.
Use of all functions is quick and easy.

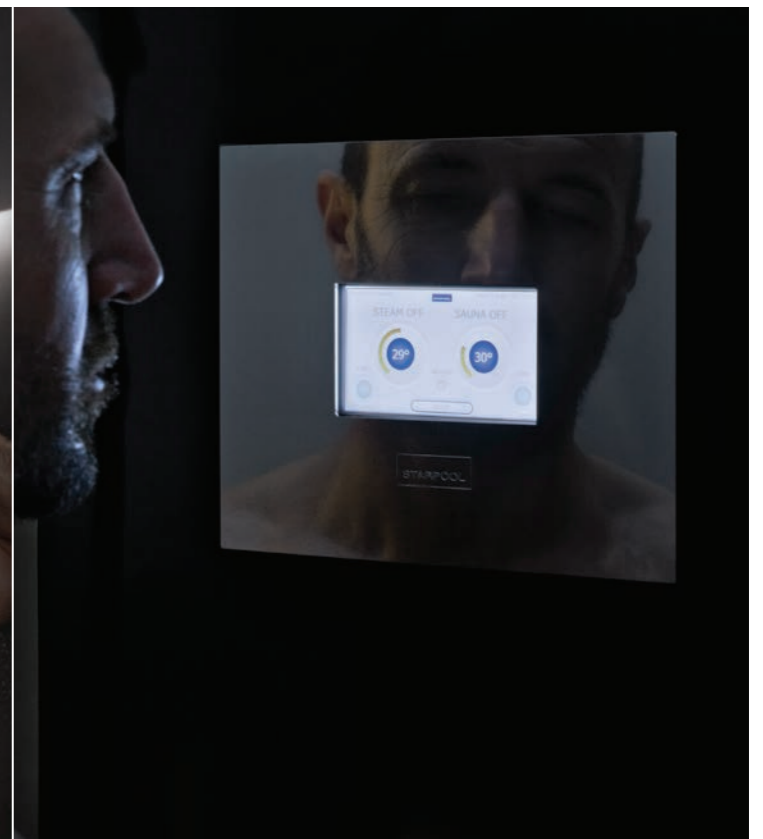

STEAM BATH

In just a few minutes, the professional direct input system raises the temperature of the steam bath to 43-45°C with a relative humidity of 98%.



SHOWER

SoulSteam also makes taking a shower a unique experience that involves all of the senses. Inspired by nature, the open-air rainfall effect gives a new dimension to moments dedicated to self-care.



NECK BLADE

The mixer regulating the temperature can transform the water blade from a warm and vigorous neck massage into a regenerating cascade that is particularly suited to cooling the body following the high temperatures experienced in the steam bath.



SOUL TOUCH

The innovative control panel offers maximum user-friendliness. All essential functions (on/off, 3 different lighting schemes, music and temperature) can be controlled by pressing the appropriate button. Touch Display also permits remote diagnostics, programmed switch-on/off, malfunction alerts and maintenance check-ups.

FUNCTIONAL DESIGN

The hidden technology, attention to detail and choice of materials offer performance and aesthetics in a perfect framework.



PureSoul

Walls and seating in ivory white glazed stoneware.

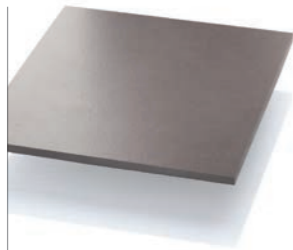

FullSoul

Walls and seating in anthracite grey glazed stoneware.

1_DOOR

Comfort, practicality and accessibility thanks to the door extended to 87 cm in width.

2_SOUL TOUCH

A practical touch screen with an intuitive interface allows swift and simple selection of the SoulSteam functions. The touch display is positioned on the technical space on the carriage where present. Where space is lacking the technical space can be installed at a remote location.

3_LIGHTING

A cascade of indirect light naturally illuminates the interior, emphasizing the soft effect of the materials. The soft, homogenous glow can be adjusted to three different degrees of intensity via the dimmable white LED strip positioned on the back wall.

4_ZERO GROUTING

With a grout surface of less than 1% of the glazed stoneware coating, SoulSteam is a product that offers the best guarantee for hygiene.

5_SUSPENDED SEATING

The suspended seating, detached from the wall, means easy cleaning and no water buildup. The glazed stoneware seating is anti-static and anti-bacterial.

6_SHOWER / JET / BLADE

A single solution: a mixer for controlling the temperature and a flow diverter for controlling the wall jet, shower head or neck blade.

Be
green



7_TECHNICAL SPACE WITH CARRIAGE

The sliding carriage containing the technical space allows ordinary maintenance to be carried out fully autonomously in simple operations. Where space is lacking the technical space can be installed at a remote location.

8_ALARM BUTTON

Stops all functions in the cabin and disconnects the power.

9_FRAME

The front wall is set in an elegant, 3-cm thick glazed stoneware framework.

PRACTICALITY

SoulSteam is a steam bath model with shower that is ready to install. Installation is fast and safe and the product can be removed and reassembled elsewhere at any time.

LOW CONSUMPTION

Energy consumption is low and compatible with domestic use.

BE GREEN

SoulSteam is fitted as standard with the "GREEN PACK" system, with automatic door closing, a door-open sensor capable of switching the heat supply off and "Energy Efficient" software to control and maintain the temperature, all of which optimizes energy consumption and avoids wasting energy.

DATA SHEET

EXTERNAL DIMENSIONS WITH INTEGRATED TECHNICAL SPACE WITH CARRIAGE (cm)	175 L x 150 P x 233 H ⓘ x2
	220 L x 150 P x 233 H ⓘ x3
	220 L x 195 P x 233 H ⓘ x4
MIN. DIMENSIONS FOR INSTALLATION WITH INTEGRATED TECHNICAL SPACE WITH CARRIAGE (cm)	185 L x 155 P x 240 H
	230 L x 155 P x 240 H
	230 L x 200 P x 240 H
EXTERNAL DIMENSIONS WITH REMOTE TECHNICAL SPACE WITH PANEL (cm)	150 L x 150 P x 233 H ⓘ x2
	195 L x 150 P x 233 H ⓘ x3
	195 L x 195 P x 233 H ⓘ x4
	285 L x 195 P x 233 H ⓘ x6
MIN. DIMENSIONS FOR INSTALLATION WITH REMOTE TECHNICAL SPACE WITH PANEL (cm)	160 L x 155 P x 240 H
	205 L x 155 P x 240 H
	205 L x 200 P x 240 H
VOLTAGE	230 VAC 1P+N+PE / 400 VAC 3P+N+PE
MAX. CONSUMPTION IN KW	3,5 - 12,5
TECHNICAL SPECIFICATION	Steam bath
TEMPERATURE	43 - 45°C
RELATIVE HUMIDITY	98%
HEATING	Direct steam inlet (with automatic introduction of essence)
LIGHTING	Ceiling strip, dimmable white LED 2700°K
MUSIC KIT	Integrated music kit with preset selection of Spa Music by Starpool and MP3 player with USB and Bluetooth technology
SEATING	Glazed stoneware <i>ton sur ton</i> with wall colour (Original Version) Black Solid Surface (Colour Version)
FRAME / DOOR	3 cm perimeter frame for front glass Door in tempered crystal, 10 mm thick Door width 87 cm Handle: steel / steel AISI 316L (Original Version) Handle: steel / black steel (Colour Version)
TAPS / SHOWER-HEAD	Steel AISI 316L (Original Version) Steel / black steel (Colour Version)
CEILING	Silver o black anodized aluminum
STRUCTURE	Wall in an Aluminium self - supporting structure, mountable in construction site (min. thickness 8,1 cm, U=0.49 W/m²K)
TECHNICAL SPACE	Choice of remote panel in area separate from cabin or alternatively in carriage (L 25 cm) to be positioned R or L of cabin
SOUL TOUCH	On technical carriage (*) if present, otherwise in technical space or remotely installed in wall

FITTINGS

PureSoul	Walls and seating in ivory white glazed stoneware
FullSoul	Walls and seating in anthracite grey glazed stoneware
DeepSoul	Walls in satin-effect green crystal
LightSoul	Walls in satin-effect light blue crystal
IntenseSoul	Walls in satin-effect plum crystal

N.B. No flooring is provided for SoulSteam: this must be realized according to the planning arrangements.

Functions that can be activated from Soul Touch (*):

ON / OFF	from Soul Touch
AROMATIZED STEAM BATH	from Soul Touch
LIGHTING	from Soul Touch
MP3 WITH MUSIC PLAY/STOP/REW/FF/VOLUME+/-	from Soul Touch

Functions that can be activated from inside cabin:

ALARM	from inside cabin
HOT/COLD WATER WALL JET	from inside cabin
CEILING SHOWER HEAD WITH HOT/COLD WATER MIXER	(*) from inside cabin
NECK WATER BLADE WITH HOT/COLD WATER MIXER	(*) from inside cabin
FLOW DIVERTER FOR SHOWER JET / HEAD / NECK WATER BLADE	(*) from inside cabin

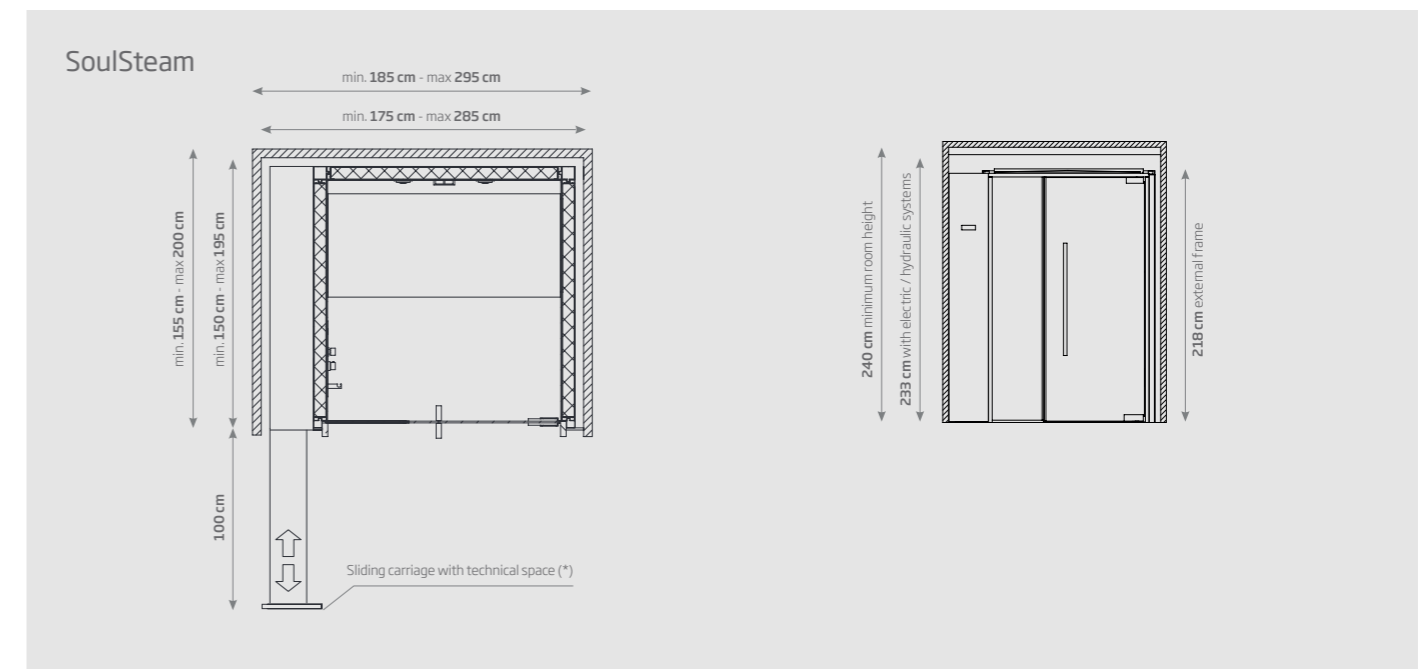

All layouts are available on page 42.
(*) where present indicates optional technologies or functions

SoulSauna

design Cristiano Mino

NEVERENDING STORY



SoulSauna

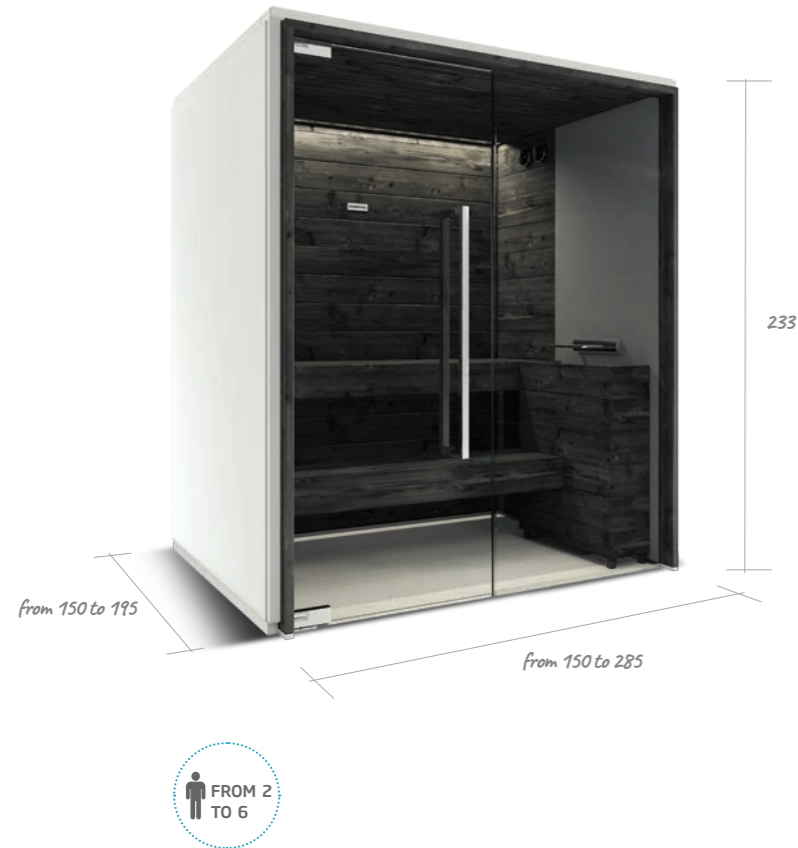

THE FINNISH FAVOURITE

SoulSauna brings up-to-date the fascinating aspects of Nordic culture, breathing new life into traditional ambiances. The Savublack version in firwood reinterprets the typical "Savusauna" or "SmokeSauna" – a Finnish favourite – where the absence of any chimney causes soot to accumulate on the seating and walls. The special black waxed treatment ensures maximum cleanliness along with a muted atmospheric effect in natural tones of coal, dark brown and anthracite. Combining tradition and innovation, there is also a version in red fir from the Fiemme Valley as well as in hemlock with its characteristic veiled white and powdery ambience.



SIMPLY CLEVER

Dimensions and settings are designed to solve even the most unusual requirements in terms of space without any sacrifice as regards comfort, quality or functionality.

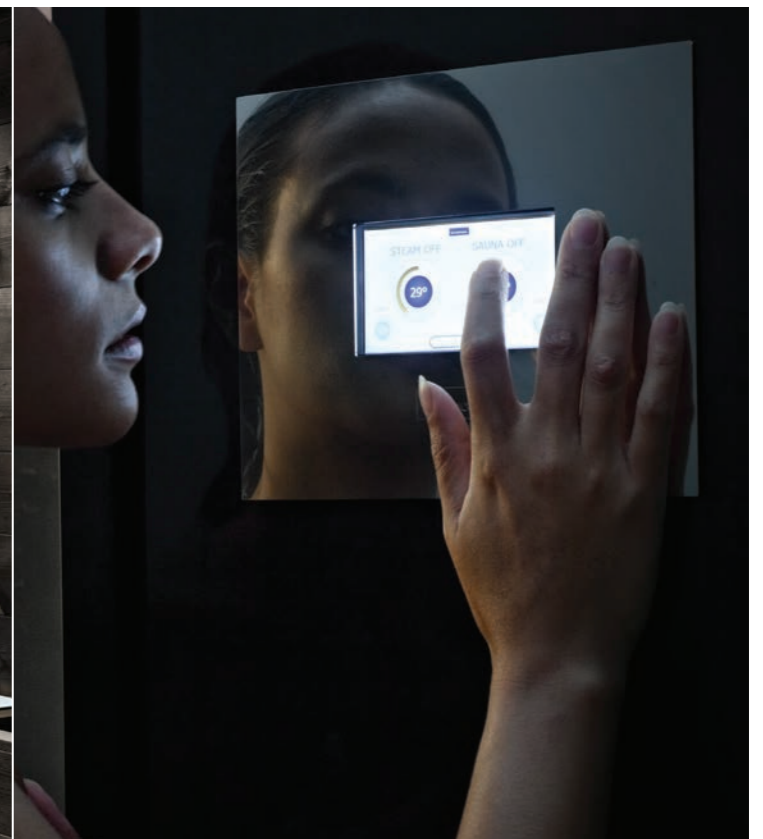
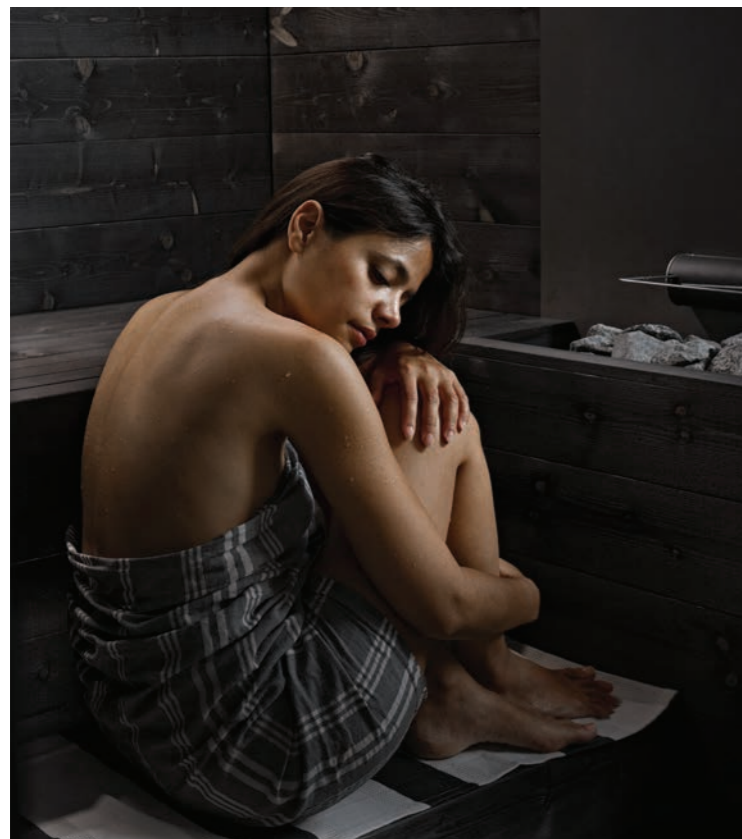

HEAT BATH

The internal stove, adjacent to the glazed stoneware wall, recreates the principles of the Finnish sauna with a temperature of 80-90°C and a relative humidity of 10-20%.



RITUALS

The internal stove permits the ritual of the "Aufguss" (steam blow). Water, perfumed by essential oil, is cast over hot stones in the stove, increasing humidity and creating an enveloping cloud of perfumed steam.



LIGHTING

A cascade of indirect light naturally illuminates the interior, emphasizing the purity of the wood to create an enveloping effect. Soft, homogenous lighting with contrasting light and shade evokes the naturally lit sauna, where the light was filtered from small windows set in the walls.



SOUL TOUCH

The innovative control panel offers maximum user-friendliness. All essential functions (on/off, 3 different lighting schemes, music and temperature) can be controlled by pressing the appropriate button. Touch Display also permits remote diagnostics, programmed switch-on/off, malfunction alerts and maintenance check-ups.

FUNCTIONAL DESIGN

SoulSauna features details, clean aesthetics and materials of natural inspiration that are pleasing to the touch, making the well-being experience yet more intensive.



FullSoul
Walls and seating
in waxed black fir.



CosySoul
Walls and seating
in red fir.



FairSoul
Walls and seating
in natural hemlock.

Wall coating behind stove

CosySoul and FairSoul are provided with ivory white glazed stoneware.

FullSoul are provided with anthracite grey glazed stoneware.

1_DOOR

Comfort, practicality and accessibility thanks to the door extended to 87 cm in width.

2_SOUL TOUCH

A practical touch screen with an intuitive interface allows swift and simple selection of the SoulSauna functions. The touch display is positioned on the technical space on the carriage where present. Where space is lacking the technical space can be installed at a remote location.

3_LIGHTING

A cascade of indirect light naturally illuminates the interior, emphasizing the natural effect of the materials. The soft, homogenous glow can be adjusted to three different degrees of intensity via the dimmable white LED strip positioned on the back wall.

4_NATURAL AIR EXTRACTION

The non-forced extraction system from below ensures constant natural air recycling and healthiness.

5_SUSPENDED SEATING

The seating, suspended from the flooring, means easy cleaning.

6_SAFETY AND CONTROL

The stove, the natural centre of the sauna, is in an absolutely safe position, isolated from the structure by means of a wall of glazed stoneware for total protection from the heat. The pressure safety system installed above the stove disconnects the supply to ensure greater safety.

Be
green



7_TECHNICAL SPACE WITH CARRIAGE

The sliding carriage containing the technical space allows ordinary maintenance to be carried out fully autonomously in simple operations. Where space is lacking the technical space can be installed at a remote location.

8_ALARM BUTTON

Stops all functions in the cabin and disconnects the power.

9_FRAME

The front wall is set in an elegant, 3-cm thick glazed stoneware framework.

PRACTICALITY

SoulSauna is a Finnish sauna model that is ready to install. Installation is fast and safe and the product can be removed and reassembled elsewhere at any time.

LOW CONSUMPTION

Energy consumption is low and compatible with domestic use.

BE GREEN

SoulSauna is fitted as standard with the "GREEN PACK" system, with automatic door closing, a door-open sensor capable of switching the heat supply off and "Energy Efficient" software to control and maintain the temperature, all of which optimizes energy consumption and avoids wasting energy.

DATA SHEET

EXTERNAL DIMENSIONS WITH INTEGRATED TECHNICAL SPACE WITH CARRIAGE (cm)	175 L x 150 P x 233 H ⓘ x2
	220 L x 150 P x 233 H ⓘ x3
	220 L x 195 P x 233 H ⓘ x4
MINIMUM DIMENSIONS FOR INSTALLATION WITH INTEGRATED TECHNICAL SPACE WITH CARRIAGE (cm)	185 L x 155 P x 240 H
	230 L x 155 P x 240 H
	230 L x 200 P x 240 H
EXTERNAL DIMENSIONS WITH REMOTE TECHNICAL SPACE WITH PANEL (cm)	150 L x 150 P x 233 H ⓘ x2
	195 L x 150 P x 233 H ⓘ x3
	195 L x 195 P x 233 H ⓘ x4
	285 L x 195 P x 233 H ⓘ x6
MINIMUM DIMENSIONS FOR INSTALLATION WITH REMOTE TECHNICAL SPACE WITH PANEL (cm)	160 L x 155 P x 240 H
	205 L x 155 P x 240 H
	205 L x 200 P x 240 H
	295 L x 200 P x 240 H
VOLTAGE	230 VAC 1P+N+PE / 400 VAC 3P+N+PE
MAX. CONSUMPTION IN KW	4,5 - 9,5
TECHNICAL SPECIFICATION	Finnish sauna
TEMPERATURE	90 - 100 °C
RELATIVE HUMIDITY	10 - 20%
HEATING	Electric stove
LIGHTING	Ceiling strip, dimmable white LED 2700°K
MUSIC KIT	Integrated music kit with preset selection of Spa Music by Starpool and MP3 player with USB and Bluetooth technology
SEATING	Waxed black fir / Red fir / Natural hemlock (Original Version) Waxed black fir (Colour Version)
FRAME / DOOR	<p>ORIGINAL VERSION</p> <p>3 cm perimeter frame for front glass with the same finishing of the internal walls</p> <p>Door in tempered crystal, thk. 10 mm</p> <p>Door width 87 cm</p> <p>Handle: polished steel AISI 316L / wood with the same finishing of the internal walls</p>
	<p>COLOUR VERSION</p> <p>3 cm perimeter frame in black or white Solid Surface (white only available for Pure Soul Version)</p> <p>Door in tempered crystal, thk. 10 mm</p> <p>Door width 87 cm</p> <p>Handle: steel AISI 316L matt black / wood with the same finishing of the internal walls</p>
STRUCTURE	Walls in a wood self-supporting structure, mountable in construction site (min. thickness 8.0 cm, U=0.67 W/m2K)
TECHNICAL SPACE	Choice of remote panel in area separate from cabin or alternatively in carriage (L 25 cm) to be positioned R or L of cabin
SOUL TOUCH	On technical carriage (*) if present, otherwise in technical space or remotely installed in wall

FITTINGS

FullSoul	Walls, seating and ceiling in waxed black fir
CosySoul	Walls, seating and ceiling in red fir
FairSoul	Walls, seating and ceiling in natural hemlock
DeepSoul	Walls in satin-effect green crystal
LightSoul	Walls in satin-effect light blue crystal
IntenseSoul	Walls in satin-effect plum crystal

N.B. No flooring is provided for SoulSauna: this must be realized according to the planning arrangements.

WALL COATING BEHIND STOVE

PureSoul	Single slab in ivory white glazed stoneware
FullSoul	Single slab in anthracite grey glazed stoneware
DeepSoul	Single slab in satin-effect green crystal
LightSoul	Single slab in satin-effect light blue crystal
IntenseSoul	Single slab in satin-effect plum crystal

Functions that can be activated from Soul Touch (*):

ON / OFF	from Soul Touch
HEAT BATH	from Soul Touch
LIGHTING	from Soul Touch
MP3 WITH MUSIC PLAY/STOP/REW/FF/VOLUME/+/-	from Soul Touch

Functions that can be activated from inside cabin:

ALARM	from inside cabin
-------	-------------------

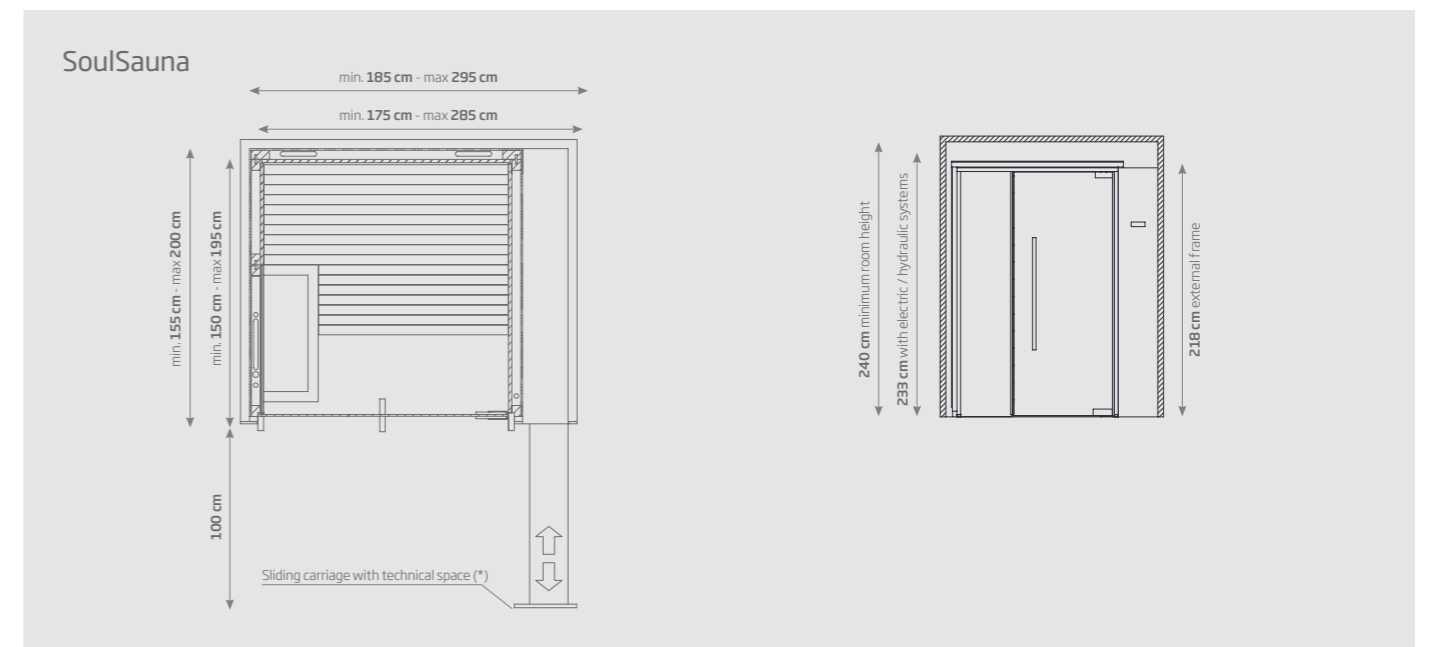

All layouts are available on page 43.

(*) where present indicates optional technologies or functions

Colour of Soul

design Cristiano Mino

THE COLOUR AS NEW SOUL OF WELLNESS



Colour SoulSteam

SoulSteam wears new chromatic proposals with emotional character. An original colour palette which opens the door to total customisation: green, plum, light blue, neutral anthracite black and ivory white are the solutions which make the steam bath even more elegant and original at the same time.



COLOUR VS BLACK

Colour becomes a perfect tailor-made dress, able to wear the glazed glass of the walls with sophistication. The black finish of the aluminium ceiling and of the seating in Solid Surface, create a perfect and rigorous design of geometric lines with perfect proportions.



TOTAL BLACK

The chromatic revolution is boosted by the total black look of taps, fittings and steam bath accessories, a novelty signed by Starpool and designer Cristiano Mino. This contemporary style characterizes the complete SoulCollection. Handles display a technical texture obtained with fine scallops combining urban aesthetics with functionality to ensure a better adherence to the grasp.



Colour SoulSauna

Sauna is considered as a piece of furniture and design, able to best integrate in the ambiances dedicated to wellbeing and to create new interior sceneries. The doors of stimulating multicolour possibilities and project freedom are opened, as colour palette does not have any nuance boundaries and gives space to customization.



FIR AND NATURAL PIGMENTS

In the Deep, Intense and Light versions the natural fir of the walls receives a waxed treatment, with exclusively natural pigments.



DETAILS

Seating and heater cover have got an opaque black finishing which highlights, by contrast, the chromatic value of sauna.



FUNCTIONAL DESIGN

Warm, enveloping, dusty colours, connected to particular states of mind give you the possibility to satisfy your personal taste and to have fun in chromatic matches.

Colour SoulSteam



PureSoul
Walls and seating in ivory white glazed stoneware.

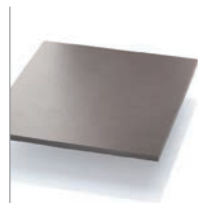

FullSoul
Walls and seating in anthracite grey glazed stoneware.

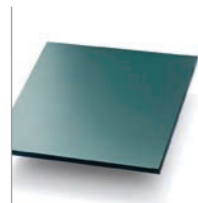

DeepSoul
Walls in satin-effect green crystal.

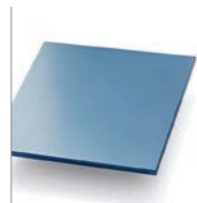

LightSoul
Walls in satin-effect light blue crystal.



IntenseSoul
Walls in satin-effect plum crystal.

Colour SoulSauna



PureSoul
Walls and seating in waxed white fir.



FullSoul
Walls and seating in waxed black fir.



DeepSoul
Walls in waxed green fir.



LightSoul
Walls in waxed light blue fir.



IntenseSoul
Walls in waxed plum fir.



COMPARATIVE TABLE



	SoulSteam	SoulSauna
TECHNICAL SPECIFICATION	steam bath	finnish sauna
TEMPERATURE	43 - 45°C	90 - 100 °C
RELATIVE HUMIDITY	98%	10 - 20%
HEATING	Direct steam inlet	Electric stove
VOLTAGE	230 VAC 1P+N+PE / 400 VAC 3P+N+PE	230 VAC 1P+N+PE / 400 VAC 3P+N+PE
CONSUMPTION IN KW	3,5 - 12,5	4,5 - 9,5
LIGHTING	Ceiling strip, dimmable white LED 2700°K	Ceiling strip, dimmable white LED 2700°K
STRUCTURE	Wall in an aluminium self - supporting structure, mountable in construction site (min. thk 8,1 cm, U=0.49 W/m ₂ K)	Walls in a wood self-supporting structure, mountable in construction site (min. thk 8,0 cm, U=0.67 W/m ₂ K)
TECHNICAL SPACE	Choice of remote panel in area separate from cabin or alternatively in carriage (L 25 cm) to be positioned R or L of cabin (not available for dim. 285 x 195 cm)	Choice of remote panel in area separate from cabin or alternatively in carriage (L 25 cm) to be positioned R or L of cabin (not available for dim. 285 x 195 cm)
SOUL TOUCH	On technical carriage (*) if present, otherwise in technical space or remotely installed in wall	On technical carriage (*) if present, otherwise in technical space or remotely installed in wall

ON/OFF	from Soul Touch	from Soul Touch
LIGHTING	from Soul Touch	from Soul Touch
MP3 WITH MUSIC PLAY/STOP/REW/FF/VOLUME+/-	from Soul Touch	from Soul Touch
ALARM	from inside cabin	from inside cabin
HOT/COLD WATER WALL JET	from inside cabin	-
CEILING SHOWER HEAD WITH HOT/COLD WATER MIXER	(*) from inside cabin	-
NECK WATER BLADE WITH HOT/COLD WATER MIXER	(*) from inside cabin	-
FLOW DIVERTER FOR SHOWER JET / HEAD / NECK WATER BLADE	(*) from inside cabin	-

(*) Where present indicate optional technologies or functions

DATA SHEET

FUNCTIONS



LAYOUT

SoulSteam

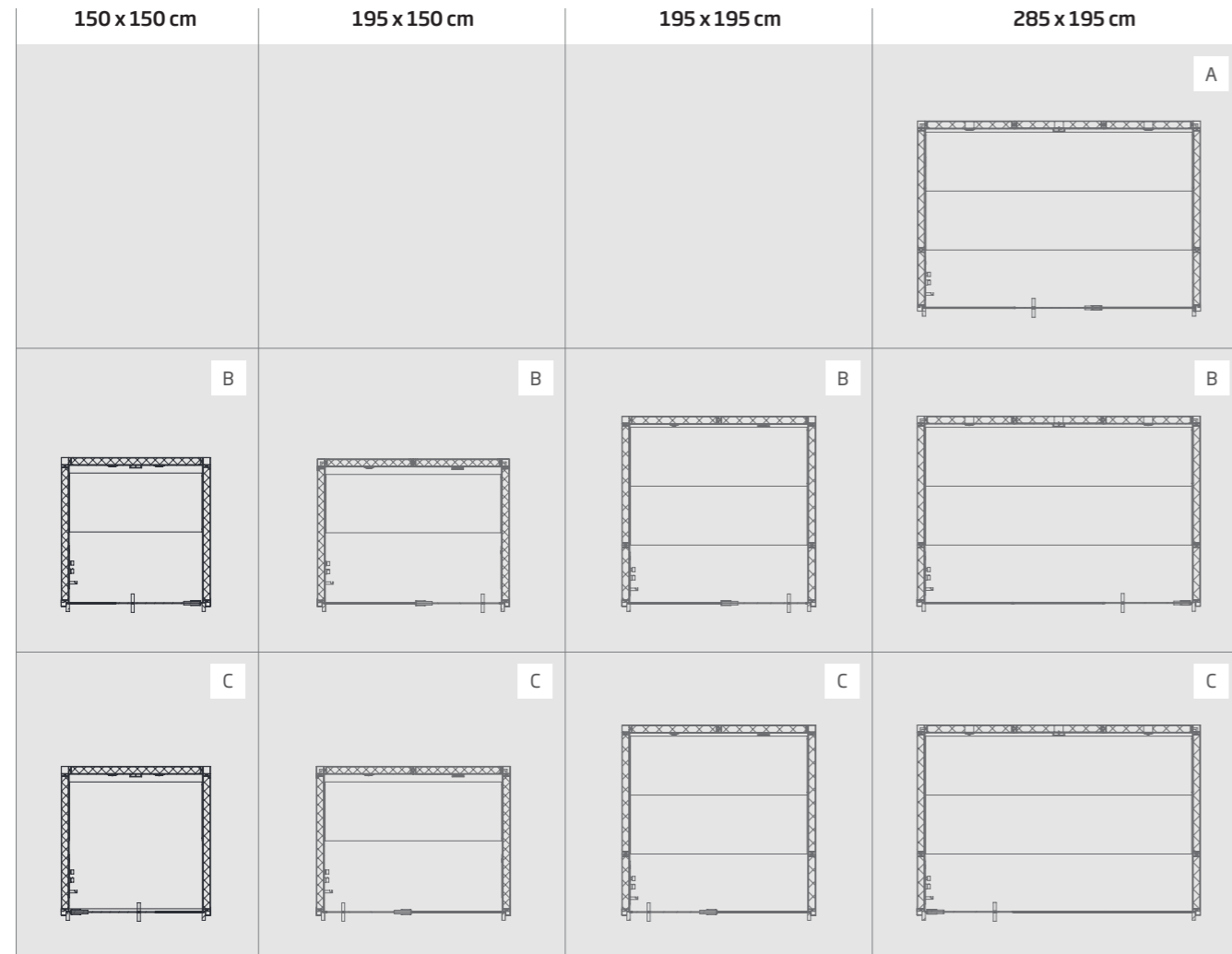

NB: The direction of door opening is determined at the moment of purchase.

SoulSauna

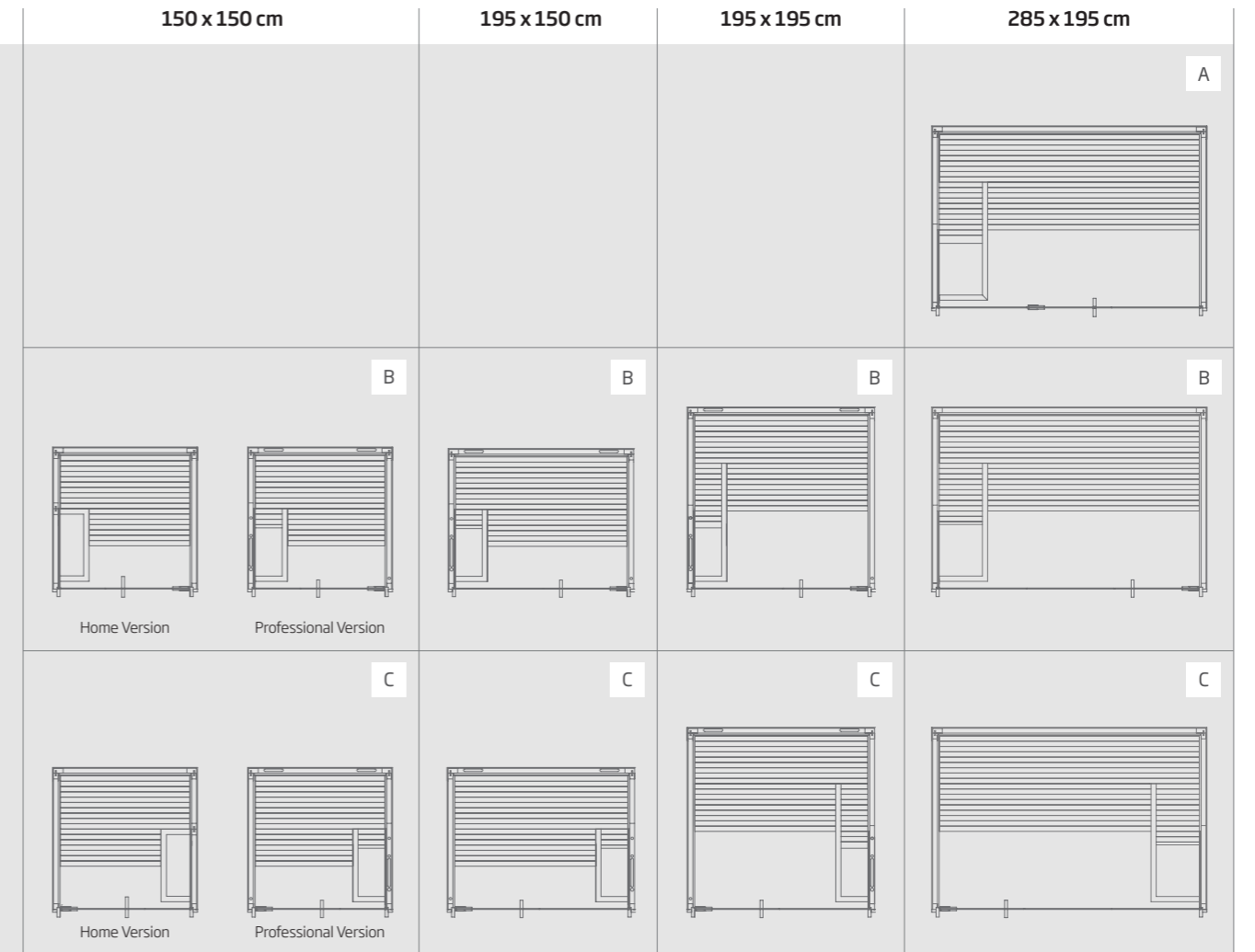

NB: The direction of door opening is determined at the moment of purchase.

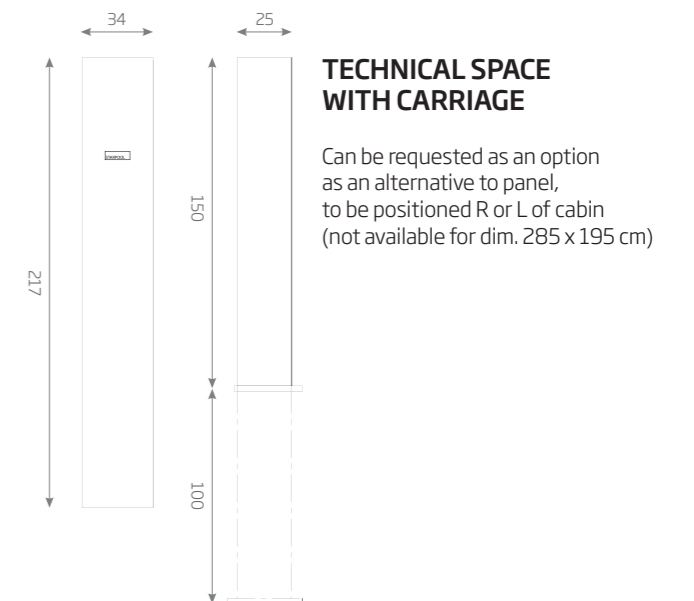
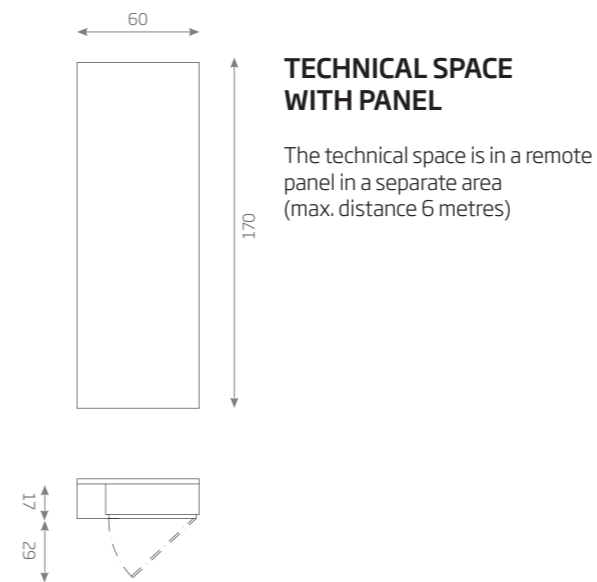
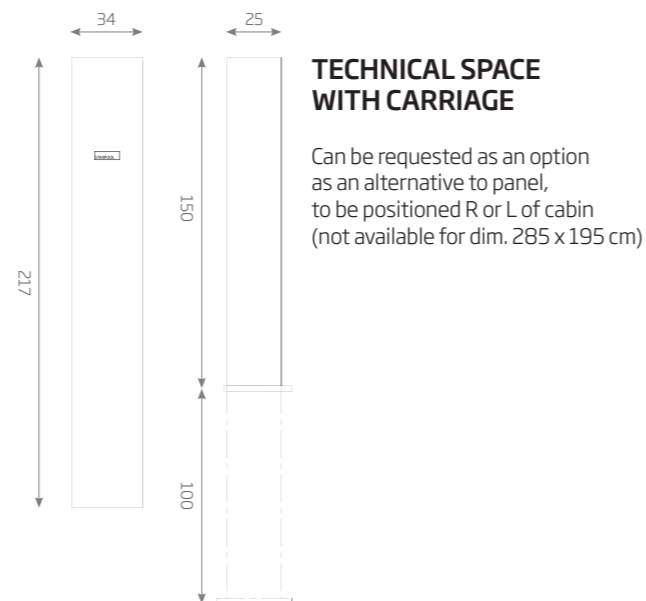
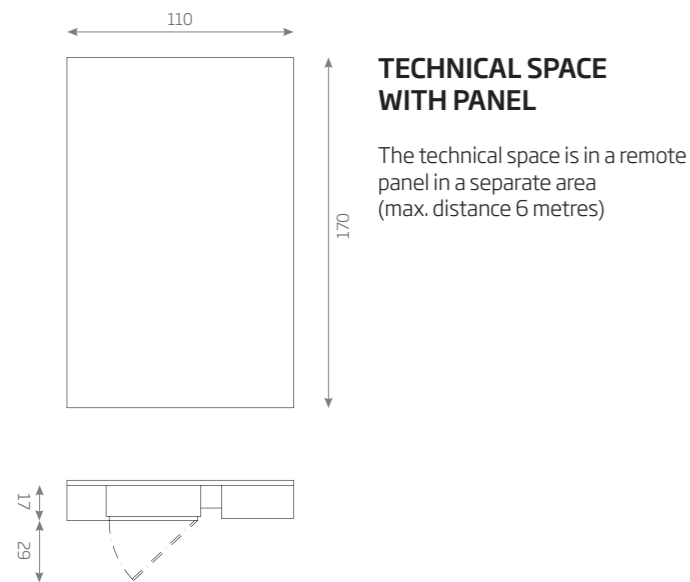

CREATE YOUR OWN SPA

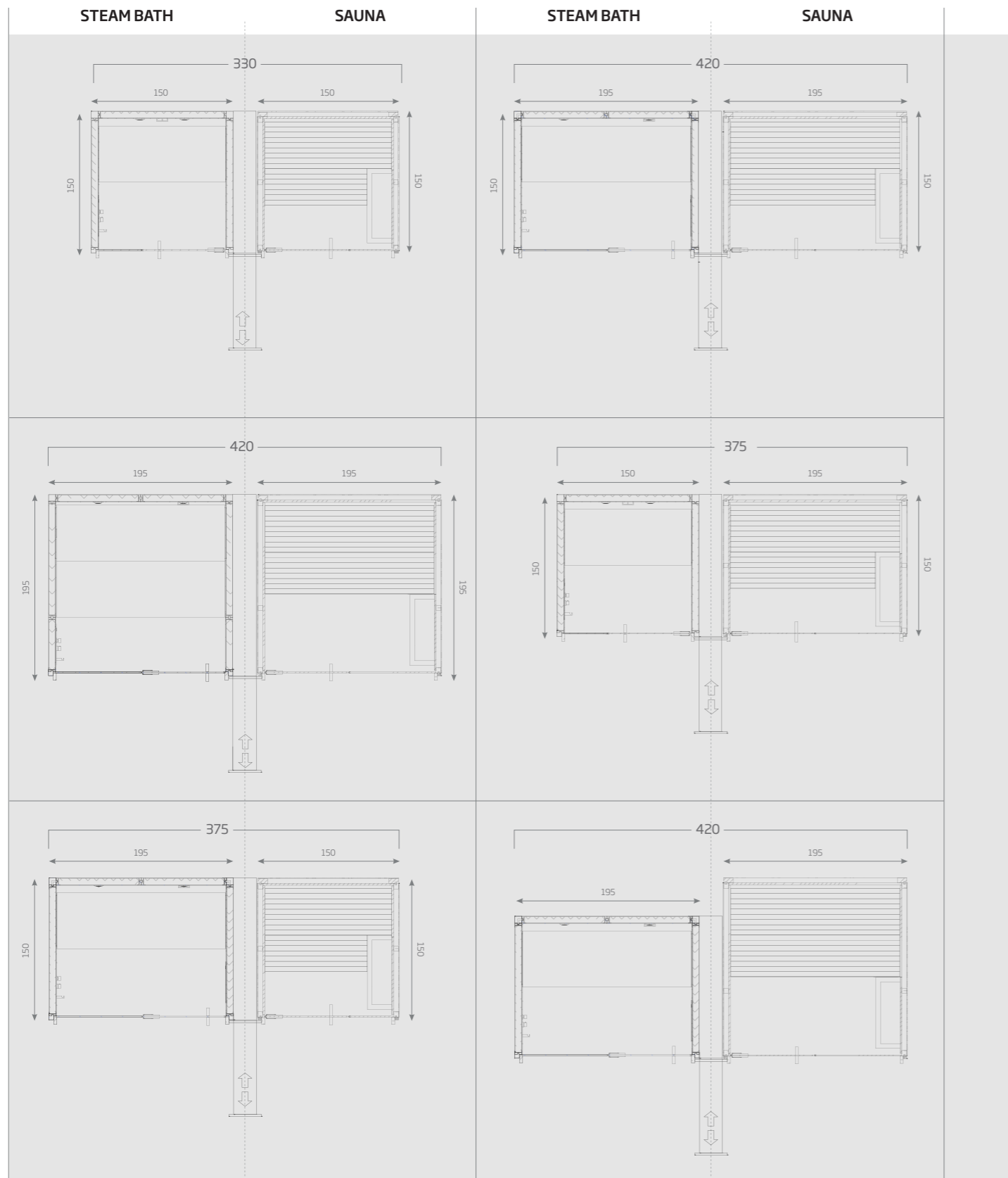

NB: The direction of door opening is determined at the moment of purchase.
The layouts shown represent just a few of the infinite possible solutions for combining "SoulSteam" and "SoulSauna".

HOW TO FIND STARPOOL

Starpool Headquarters
Starpool s.r.l.
 Ziano di Fiemme
 Via Stazione, 25
 38030 Trento
 T +39 0462 571881
 info@starpool.com

Showrooms
 Almaty
 Astana
 Bruxelles
 Innsbruck
 Kuala Lumpur
 Lisboa
 Madrid
 Milan
 Minsk
 Moscow
 Munich
 Singapore
 Zagreb
 Zurich

Starpool Austria
 Grabenweg, 68 - Soho 2.0
 60020 Innsbruck - A
 T T +43 512 341189
 austria@starpool.com

Starpool Middle East
 DWC Business Center
 PO - box 712384 - Dubai UAE
 T. +971 506029969
 emirates@starpool.com

Starpool Asia Pte Ltd
 Singapore 1 Kaki Bukit Road, 1, #02-14
 Enterprise One 415934
 T +65 68423166
 singapore@starpool.com

MORE THAN **3.000 PROJECTS** IN THE WORLD
 MORE THAN **500 RESIDENCES** FURNISHED
 WITH **STARPOOL PRODUCTS**

FOLLOW US

[in /Starpool](#) [/starpool.official](#) [f /StarpoolOfficial](#) [/Starpool](#)
starpool.com

Starpool, Wellness Concept, Sweet, Mediterranean Bath, Rivestimento Milano, Rivestimento Cortina, Relax, Excite, Purify sono marchi di proprietà Starpool s.r.l. registrati in paesi dell'Unione Europea e nel mondo.
 SweetProMed, SweetProSauna, SweetProSteam, SweetSpa, SweetSauna50, SweetSense, SweetSauna90, SweetSpa Eramosa, SpaTable, sono brevetti, modelli o domande di brevetto di Starpool s.r.l. in paesi dell'Unione Europea e del mondo. Starpool® si riserva il diritto di modifiche ai prodotti e alla documentazione senza obbligo di preavviso alcuno per un continuo processo di sviluppo e miglioramento del prodotto.

Concept: Starpool • Graphic design: Creativamente (PD) • Revision 2019: Davide Giudici
 Art director/copywriter: Marketing Starpool • Photos: Germano Borrelli - Damiano Nava - Gaia Panozzo
 Photorealistic render: Nudesign Studio • Printed by: Litografia Editrice Saturnia (TN)

STARPOOL

wellness concept



AmstelConcepts BV

Assumburg 152 B

1081 GC Amsterdam,

The Netherlands

+31 20 6693560

info@amstelconcepts.com

